



INSTRUCTIONS
MANUAL

ADHESIVE MELTER **MICRON+** PISTON SERIES

HMI	v1.1.2
TC	v1.0.84
IO (FM)	v1.0.0

Published by:

Focke Meler Gluing Solutions, S.A.

Pol. Arazuri-Orkoien, c/B, nº3 A
E-31170 Arazuri - Navarra - Spain
Phone: +34 948 351 110
info@meler.eu - www.meler.eu



Focke Group

Edition February 2022

© Copyright by Focke Meler

All rights reserved. Its reproduction, diffusion or use by electronic or other means of all or any part of this document without the express authorization of its owner is strictly prohibited.

The specifications and information contained in this manual may be modified without prior notice.

The official language of this manual is only the English language. The remaining versions of the manual in other languages are mere translations without any official value or efficacy. In case of discrepancies or contradictions between the English version of the manual and any other version of the manual written in another language, the English version will prevail.

TABLE OF CONTENTS

1. SAFETY GUIDELINES	1-1
General	1-1
Symbols	1-1
Mechanical components	1-2
Electrical components	1-2
Hydraulic components	1-2
Pneumatic components	1-2
Thermal components	1-3
Materials	1-3
Noise emission declaration	1-3
Intended use	1-4
Limited use	1-4
2. INTRODUCTION	2-1
Description	2-2
Modes of operation	2-2
Hot-melt melter/applicator identification	2-2
Main components	2-3
Control panel components	2-4
Automatic feeder main components (optional)	2-5
General	2-5
Notes	2-6
MICRON+ series range	2-6
Incompatibilities	2-7

MICRON+ range option accessories	2-7
3x400 & 3x480 whitout neutral power supply voltage option	2-7
Automatic feeder option	2-7
Warning light option	2-7
VP option	2-7
Optional equipment	2-8
3. INSTALLATION	3-1
Introduction	3-1
Installation requirements	3-1
Electrical Consumption	3-2
Compressed air	3-2
Other factors	3-3
Unpacking	3-3
Contents	3-3
Mounting the equipment	3-3
Electrical power connection	3-4
Pneumatic connection	3-5
Hose and applicator connection	3-6
Parameter Programming	3-6
External I/O connections	3-6
Connecting external inputs and outputs	3-9
Interpretation of external inputs and outputs	3-10
Connecting zone inhibition	3-12
Connecting product passage signal (Flowmeter)	3-13
Wireless connection (Wi-Fi)	3-13
Automatic feeder assembly	3-14
Pneumatic connection	3-14
Suction tube connection	3-14
Placing the suction tube	3-14
Electrical connections	3-15

4. MELTER OPERATION	4-1
General information	4-1
Filling the tank	4-1
Manual starting up the melter equipment	4-2
Manual pumping permission	4-3
Melter equipment display	4-4
Date and time Menu	4-4
General characteristics	4-5
Navigation icons	4-5
Save changes	4-5
Explanation of the screen contents	4-5
Home display	4-6
General temperature status	4-6
Alarms status	4-7
Calendar status	4-7
Adhesive level status	4-7
Pumping status	4-8
Temperature status	4-8
Temperature and Heating Shortcut displays	4-9
Programming of temperatures	4-10
Programming of statuses	4-10
Calendar	4-10
Units and Language Menu	4-11
Date and time configuration	4-11
Alarms and warnings	4-12
Main Menu	4-12

'1. Heating' Menu	4-13
1.1 Heating zones	4-13
1.2 Sequential Heating	4-14
1.3 Inhibitions	4-14
1.4 Auto Standby - OFF	4-15
1.5 Heating Extra settings	4-16
'2. Extra settings' Menu	4-17
2.1 Password management	4-17
2.2 Extra settings	4-18
2.3 Configuration of input and output signals	4-19
2.4 Restore default values	4-19
'3. Statistics' Menu	4-20
'4. Load' Menu	4-20
Screen 1: Minimum adhesive level sensor	4-20
Screen 2: Automatic adhesive feeder	4-20
Automatic pumping block function	4-21
'Automatic pumping block' enabled	4-21
'Automatic pumping block' disabled	4-22
'Off after reset' function	4-23
'Off after reset' enabled	4-23
'Off after reset' disabled	4-24
Configuration of turning on and activating pumping	4-24
Wireless communication (Wi-Fi)	4-26
Connection configuration	4-26
Flowmeter	4-27
System calibration	4-27
Calculating the adhesive density	4-28
Product configuration	4-28
Product selection	4-30
Flowmeter statistics	4-31

Standby function	4-32
Turning off the melter equipment	4-32
Use of the automatic feeder	4-33
Start up and automatic process	4-33
Sensitivity adjustment	4-34
Positioning of the level sensor	4-34
Application for PC	4-35
5. MAINTENANCE	5-1
Equipment cleaning	5-1
System depressurisation	5-2
Access to pneumatic unit	5-3
Maintenance of the filters	5-3
Changing the pump filter	5-3
Changing the inlet filter	5-4
Cleaning the tank	5-5
Changing adhesive type.	5-5
Cleaning burnt adhesive	5-5
Emptying the tank	5-6
Safety Thermostat	5-7
Remove the equipment from its base	5-7
Automatic feeder maintenance	5-8
Cleaning of the unit	5-8
Pneumatic system	5-8
Control of the load sensor	5-9
Inspection of the aspiration tube	5-9
Filter maintenance	5-9
Control of pneumatic vibrator	5-9

6. TECHNICAL CHARACTERISTICS	6-1
Generals	6-1
Dimensions	6-3
Accessories	6-5
Low level detection system	6-5
Caster system	6-5
Adaptation plate for previous models	6-5
7. ELECTRICAL DRAWINGS	7-1
8. PNEUMATIC DIAGRAM	8-1
Components list	8-1
7 cm³/stroke pump	8-1
19 cm³/stroke pump	8-1
With electro-pneumatic pressure regulator VP	8-1
Pneumatic connection for 7 cm³/stroke PUMP	8-2
Pneumatic diagram for 7 cm³/stroke PUMP	8-3
Pneumatic connection for 19 cm³/stroke PUMP	8-4
Pneumatic diagram for 19 cm³/stroke PUMP	8-5
Electro-pneumatic connection with pressure regulator VP. 7 cm³/stroke PUMP	8-6
Electro-pneumatic diagram with pressure regulator VP. 7 cm³/stroke PUMP	8-7
Electro-pneumatic connection with pressure regulator VP. 19 cm³/stroke PUMP	8-8
Electro-pneumatic diagram with pressure regulator VP. 19 cm³/stroke PUMP	8-9

9. SPARE PARTS LIST	9-1
A. TANK ASSEMBLY	9-4
B. DISTRIBUTOR UNIT	9-5
C. PUMP ASSEMBLY	9-6
D. PNEUMATIC UNIT ASSEMBLY 7cc	9-7
D. PNEUMATIC UNIT ASSEMBLY 19cc	9-8
E. CHASSIS ASSEMBLY	9-9
F. ELECTRONIC ASSEMBLY	9-10
G. ELECTRIC ASSEMBLY	9-11
H. AUTOMATIC FEEDER. FILTER- SENSOR ASSEMBLY	9-12
I. AUTOMATIC FEEDER. SUCTION TUBE	9-13
J. AUTOMATIC FEEDER. VALVE ASSEMBLY	9-14
EC DECLARATION OF CONFORMITY	10-1
EC DECLARATION OF CONFORMITY <i>(Only for equipments with wifi system integrated)</i>	10-3

This page is intentionally left blank.

1. SAFETY GUIDELINES

General

The information contained in this section applies not only to everyday equipment operation, but also to any procedure carried out on it, whether for preventive maintenance or in the case of repairs and the replacement of worn out parts.

It is very important to observe the safety warnings in this manual at all times. Failure to do so may result in personal injury and/or damage to the equipment or the rest of the installation.

Before beginning work on the equipment, read this manual carefully, and in case of any doubt, contact our Technical Service Center. We are available for any clarification that you might need.

Keep manuals in perfect condition and within reach of personnel that use the equipment and perform maintenance on it.

Also provide necessary safety material: appropriate clothing, footwear, gloves and safety glasses.

In all cases, observe local regulations regarding risk prevention and safety.



Symbols

The symbols used on both the melter/applicator equipment and in this manual always represent the type of risk we are exposed to. Failure to abide by a warning signal may result in personal injury and/or damage to the equipment or the rest of the installation.

Warning: Risk of electrical shock. Carelessness may produce injury or death.



Warning: Hot zone with high temperatures. Risk of burns. Use thermal protective equipment.



Warning: System under pressure. Risk of burns or particle projection. Use thermal protective equipment and glasses.



Warning: Important information for the correct use of the system. May include one or several of the previous hazards, and therefore must be kept in mind to avoid damage and injury.



Warning: Dangerous area. Risk of entrapment. Carelessness may produce injury or death.



Mechanical components



The hot-melt installation, which is installed to this device, requires moving parts that can cause damage. Use the equipment correctly, and do not remove the safety guards while the equipment is in operation; prevent the risk of possible entrapment due to moving mechanical parts.

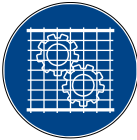

Do not use the equipment if the safety devices are not in place or appear to be inadequately installed.

For maintenance or repair operations, stop the movement of moveable parts by turning off the main switch.

The device has no moving mechanical parts, so it does not pose risks to consider in this section.

Electrical components



The system works with single-phase or three-phase current of a certain power. Never handle the equipment with the power connected, as this may result in powerful electrical shocks.



The installation must be correctly grounded.

The installation's power cable conductors must match the required electric current and voltage.

Periodically inspect the cables to check for crushing, wear and tear, as well as to prevent tripping and falls as a result of their placement.

Although the system meets EMC requirements, it is inadvisable to use devices that transmit high levels of radiation, i.e., mobile phones or soldering equipment in their vicinity.

Hydraulic components



As this is a pressurized system, precautions related to this type of equipment must be observed.

Before each operation, always make sure that the adhesive circuit is completely free of pressure. There is a high risk of hot particle projection, along with the corresponding danger of burns.

Use caution with the residual pressure that may remain in the hoses when the adhesive cools. When reheated, there is a risk of hot particle projection if the outputs are left open.

Pneumatic components



Some equipment uses compressed air to 6 bar pressure. Before any manipulation, please ensure that the circuit has lost fully air pressure. The risk of projection of particles at high speed can cause injury to a certain severity.

Extreme precautions with the residual pressure that could be contained in the circuit, before disconnecting any pneumatic feeding tube.

Thermal components

The entire system works with temperatures that can exceed 200°C (392°F). The equipment must be operated using adequate protection (clothing, footwear, gloves and protective glasses) that completely cover exposed parts of the body.

Keep in mind that, due to the high temperatures reached, the heat does not dissipate immediately, even when the power (in this case, electric) source is disconnected. Therefore, use caution, even with the adhesive itself. It may remain very hot, even in a solid state.

In case of burns:

1. If the burn is the result of contact with melted adhesive, do not try to remove the adhesive material from the skin. Do not try to remove it once it has solidified either.
2. Cool the affected area down immediately with lots of cold and clean water.
3. Seek medical attention as soon as possible either from the company's medical service or the nearest hospital. Provide the medical staff with the Safety Information Sheet of the adhesive.



Materials

Meler systems are designed for use with hot-melt adhesives. They should not be used with any other type of material, and especially not with solvents, which may cause personal injury or damage to internal system components.

Some units are specifically designed to use polyurethane reactive (PUR) hot-melt adhesives. Using PUR on a unit that is not prepared for that purpose may cause severe damage to the unit.

When using adhesive, follow the corresponding guidelines found in the Technical and Safety Sheets provided by the manufacturer. Pay special attention to the advised work temperatures in order to prevent adhesive burning and degradation.

Ventilate the work area adequately in order to remove the vapors produced. Avoid the prolonged inhalation of these vapors.

Always use original Meler components and replacement parts, which guarantee the correct system operation and service.



Noise emission declaration

The A-weighted emission sound pressure level (L_{pA}) of the unit in operation does not exceed 70 dB(A) under any circumstances.

The maximum C-weighted sound pressure level (L_{pCpeak}) and the A-weighted sound power level (L_{WA}) do not exceed values worthy of mention and thus do not represent a specific risk that must be taken into account.



Intended use

The equipment are designed to be used in the following conditions:

- Hot-melt adhesive fusion and pumping at temperatures up to 200 °C (392 °F). Consult with Meler technical service to operate with higher working temperatures.
- Use of equipment with Meler accessories.
- Installation of equipment according to the security regulations currently in force and the instructions provided in this manual (anchoring, electrical connection, hydraulic connection, etc).
- Use of equipment in non-explosive, non-chemically aggressive environments.
- Use of equipment following the safety instructions indicated in this manual, as well as on the labels accompanying the equipment, using adequate means of protection during each mode of operation.



Limited use

The equipment should never be used under the following conditions:

- Use with reactive polyurethane or any other material that might cause safety or health risks when heated.
- Use of equipment in environments where cleaning is necessary using water jets.
- Use of equipment to heat or melt food products.
- In potentially explosive atmospheres, aggressive chemical environments or outdoors.
- Use or operation without adequate safety protection.
- If the person in question does not have the necessary training to use the unit or to apply all of the necessary safety measures.



Note: Do not modify the equipment or use components that were not supplied by Meler. For any modification of a component of the equipment or part of the installation, you must firstly consult the After-Sales Service

2. INTRODUCTION

In this manual you will find information about the installation, use and maintenance of the hot-melt adhesive melter/appliator in meler's MICRON+ series.

The 'MICRON+' series includes the 5, 10, 20 and 35 liter range of hot-melt adhesive melters/appliators.

Most of the photographs and illustrations that appear in this manual refer to the 5-liter 'MICRON+' melter/appliator. This model has been used as a reference for writing this manual as its main characteristics, with the exception of the tank capacity and the connection outputs are the same as those in the rest of the 'MICRON+' series.



Description

The 'MICRON+' are designed for use with 'meler' hoses and applicators in hot-melt adhesive applications. Their different variations – line, coating or swirl-spray – cover a wide range of applications, being very versatile in all markets where they are used.

Modes of operation

The unit has the following operating modes:

- **READY Mode (Prepared).** The melter keeps the components hot at the programmed working temperature. The pump is kept idle, awaiting an adhesive pump request.
- **RUNNING Mode (in Operation).** The unit pumps adhesive, and all programmed working conditions are correct.
- **STOPPED Mode (Pumping disabled).** The pump is kept disabled until the pump is either manually or automatically activated.
- **Heating Mode.** The unit heats the areas up to the programmed temperature. The pump is kept disabled.
- **STANDBY Mode (Low consumption).** The melter remains in standby while maintaining all active areas at a programmable temperature. The pump remains disabled.
- **WARNING Mode.** The melter detects an incorrect operation or warns the operator about the event. The unit can continue to operate.
- **ALARM Mode.** The melter detects an operation error or warns the operator about the event. Depending on the type of alarm, the unit may continue to operate for a programmed amount of time.
- **ERROR Mode.** The melter detects an operation error or warns the operator about the event. The unit cannot continue to operate, and pumping is stopped immediately. Depending on the type of error, the unit disconnects heating from all the areas.
- **OFF Mode.** The unit remains off with no areas heated and the pump disabled. The power and pneumatic supply from the network to the unit is maintained.

Hot-melt melter/applicator identification

When placing orders for replacement parts or requesting help from our service center, you should know the model and reference number of your hot-melt melter/applicator.



Main components

1. Front control card
2. Access door to the electric/pneumatic area
3. Tank access lid
4. Pump air pressure regulator
5. Air pressure gauge
6. Characteristics plate
7. Main switch
8. Hose output distributor (up to 6 hydraulic connections)
9. Hose-applicator electrical connections
10. Compressed air hook-up (Max. 6 bar)
11. Set of pump drain valve and filter.



Control panel components

1. Touch screen.
2. Status central leds (GREEN, YELLOW, RED).
3. RED led 'pumping OFF'.
4. STOP RED Button 'Start/Stop Pump'.
5. Touch screen ON/OFF button.
6. GREEN led 'power ON'.

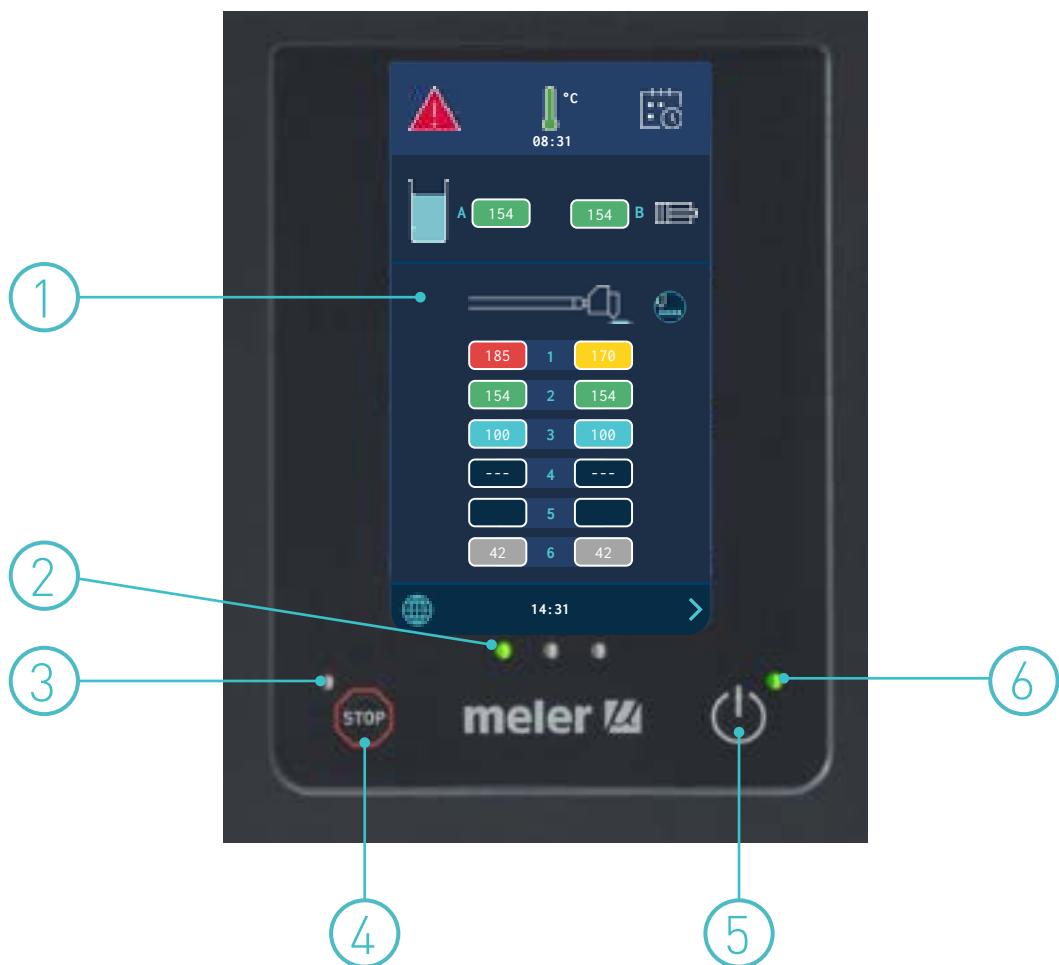

Automatic feeder main components (optional)

General

1. Flexible Load Tube
2. Rotary fitting
3. Unload Filter
4. Load Sensor
5. Tank access lid
6. Output air supply to the suction area
7. Electric load valve
8. Input air supply (from the grid)
9. Junction box
10. Level sensor amplifier
11. Sensor and power supply connector
12. Pneumatic vibrator
13. Suction area
14. Air feeding tube



MICRON+ series range

MICRON+	5	/	4	M01	200	BP	7	400N	-	LD2	B	VP	MB	W	S	E	F	INOX
										Shaft Material _ (in blank): Standard • INOX: stainless								
										Certifications _ (in blank): CE • UL: UL								
										Flowmeter _ (in blank): Without flowmeter • F: With flowmeter								
										Melter Control (in blank): Internal • E: Prepared for external control								
										Starbi integration _ (in blank): Not integrated • S: Starbi integrated (2 channels)								
										Communications 2 _ (in blank): Without • B: With Bluetooth • W: Wifi								
										Communications 1 _ (in blank): No communications • MB: ModBus • PB: ProfiBus • PN: ProfiNet • EN: Ethernet-IP • EC: Ethercat								
										Pressure proportional system _ (in blank): Not prepared • VP: Prepared								
										Light tower _ (in blank): Not prepared • B: Prepared								
										Level detector _ (in blank): Prepared for floating detector • LD2: With capacitive detector installed								
										Lid _ (in blank): Standard lid • CG: With granulate feeder installed								
										Power supply _ 400N: 3N~400V 50/60Hz + PE • 400: 3~400V 50/60Hz + PE • 230: 3 ~ 200/240V 50/60Hz + PE • 480: 3~480V 50/60Hz + PE								
										Pump size _ 7: 7cc/stroke • 19: 19 cc/stroke								
										Pump type _ BP: Piston								
										Maximum temperature _ 200: 200°C • 230: 230°C								
										Sensor type _ M01: Pt100 • N01: Ni120 • HB01: Pt100 Bühnen • R01: NTC-R								
										Electrical outputs _ 2 • 4 • 6								
										Tank capacity _ 5: 5kg • 10: 10kg • 20: 20kg • 35: 35kg								
MICRON+ series																		

Notes

- All versions are prepared for floating detector.
- When the automatic feeder is included, the suction tube and hose must be ordered separately.
- The tower light must be ordered separately.
- The floating detector must be ordered separately.
- The VP system must be ordered separately.
- External control must be ordered separately.
- For 3~400V 50/60Hz + PE & 3~480V 50/60Hz + PE, the transformer base is included.

Incompatibilities

- 230°C & Float sensor
- Micron 35 & 7cc/stroke piston pump
- Micron 35 & 3~400V 50/60Hz + PE
- Micron 35 & 3~480V 50/60Hz + PE
- Automatic feeder & Float sensor
- Automatic feeder & Capacitive sensor
- Automatic feeder & Tower light
- Float sensor & Capacitive sensor
- Bluetooth & Wifi
- UL & prepared for external melter controller
- UL & HB01
- UL & 230 °C
- UL & integrated Starbi
- UL & Bluetooth
- UL & Flowmeter
- UL & 400
- CE & 480
- 6 electrical outputs & integrated Starbi

MICRON+ range option accessories

If some of the different machine configuration options have been chosen, it will be necessary the following accessories:

3x400 & 3x480 whitout neutral power supply voltage option

The transformer for the 5, 10 and 20l machine will be included.

Automatic feeder option

The automatic adhesive feeder will be included and is the same for the 5, 10, 20 and 35l machines. Suction lance and hose have to be order separately.

Warning light option

The warning light must be requested separately. There is a choice of the low level and colourless (white) indicator light or the low level and temperature OK indicator light (green). They are both the same for all machines.

VP option

The VP proportional valve system must be requested separately. It is the same for all machines in all cases.

Optional equipment

To increase the functionality of the melter machines, the following optional elements can be incorporated:

- **Low level of melted adhesive detection system.** This can be fitted to all the machines in float switch or capacitive sensor options.
- **Adaptation plate for previous models.** For adapting ST machines, the previous 4, 8 and 16l machines and MICRON range 5, 10 20 and 35 liters.
- **4 casters:** Only for 20 and 35l machines.

3. INSTALLATION

Warning: The melters/applicators are equipments with current technology and with certain foreseeable risks. Therefore, only allow qualified personnel with sufficient training and experience to use, install or repair this equipment.



Introduction

The 'MICRON+' series melters/applicators are delivered with all the materials necessary for their installation. However, some components must be provided by the user himself, according to the location and connections in each particular installation:

- Anchoring screws for the melter/applicator equipment
- Power cord and plug for electrical power
- Pneumatic pipe and connection to the compressed air system
- Multicore cable for external electrical control
- Optionally, a gas ventilation system

Installation requirements

Before installing 'MICRON+' series melter/applicator equipment, we must make sure that the space assigned to it permits installing, connecting and using the entire system. Similarly, we must check to see that the electrical and pneumatic supplies meet the necessary requirements of the melter/applicator equipment being installed.

Free space



Item	Description	Dimension
A	EQUIPMENT LENGTH	5 l 588 mm
		10 l 671 mm
		20 l 671 mm
		35 l 742 mm
B	EQUIPMENT WIDTH	5 l 339 mm
		10 l 339 mm
		20 l 383 mm
		35 l 435 mm
C	EQUIPMENT HEIGHT	5 l 481 mm
		10 l 481 mm
		20 l 526 mm
		35 l 673 mm
D	EQUIPMENT HEIGHT WITH LID OPEN	5 l 628 mm
		10 l 760 mm
		20 l 875 mm
		35 l 1067 mm
E	EQUIPMENT LENGTH WITH ELECTRICAL CABINET OPEN	5 l 838 mm
		10 l 921 mm
		20 l 921 mm
		35 l 992 mm

Electrical Consumption

In order to install a 'MICRON+' series melter/appliator, we should take into consideration the total consumption of the installation, including the consumption of the installed hoses and applicators.



Before connecting, make sure that the voltage that is being connected to the melter/appliator is the correct one appearing on the equipment's characteristics plate.

Connect the machine and check to see if it is well grounded.



Warning: Risk of electrocution. Even when the equipment is turned off, voltage remains in the intake terminals, which may be dangerous during internal equipment manipulations.

Install a power switch for disconnecting the melter/appliator equipment from the electrical network. It must be protected against overload and short circuits by circuit breaker and install appropriate personal protection leads to mass by differential switch.

Consumption figures, according to melter/appliator and output configuration, are included in the table in the section 'Electrical power connection'.

Compressed air

To install 'MICRON+' series melters/appliators, it is necessary to have a dry, non-lubricated compressed air system with a maximum pressure of 6 bar.

The applicator's internal pneumatic equipment is able to work with a minimum of 0.5 bar, however, pressure lower than this will cause intermittent operational anomalies.

The air consumption is according to the number of stroke made by the pump cylinder, which in turn depends on the adhesive consumption during the application. It is therefore necessary to estimate this consumption in all cases.

Generally speaking, we can provide as a maximum consumption value 40-50 l/min for a pressure of 6 bar at maximum pump speed.

Other factors

While installing 'MICRON+' series melters/applicators, other practical considerations should be kept in mind:

- Keep the load opening accessible for comfortable melter/applicator filling.
- Position the melter/applicator equipment in such a way that you can easily see the front panel display where temperatures and possible alarm signals are shown.
- As much as possible, try to avoid unnecessarily long hoses that result in elevated electrical energy consumption levels and pressure drops.
- Do not install the melter/applicator equipment beside powerful heat or cooling sources that may have distortional effects upon its operation.
- Avoid melter/applicator vibrations.
- Make sure that the melter/applicator maintenance areas (filter, purging valve, tank interior, etc.) are easily accessible.

Unpacking

Before proceeding with the installation of the melter/applicator, it should be removed from its location on a pallet and examined in order to detect any possible breakage or deterioration. Communicate any defect, even to the outer packing materials, to your Focke Meler Representative or to the Main Office.

Contents

The 'MICRON+' series packing materials may contain accessories that form part of the same order. If this is not the case, the following are the standard components that accompany the melter/applicator:

- Instruction manual.
- Guarantee card.
- Hose couplings.
- Set connectors for Inputs / Outputs.

Mounting the equipment

For mounting the 'MICRON+' series set the base in the desired location using the indicated holes M8 screws.

The 'MICRON+' series equipments have an optional adaptation plate for fixing 'MICRON+' 5, 10, 20, 35 and previous 'MICRON' range 4, 8, 16, 32 and ST machines. To mount the base plate, place it on the machine bench and adjust its position. Mark and drill the four holes for the base plate's M8 fastening screws. The holes may be threaded or non-threaded, depending on the bench to which they are being attached.





Warning: Make sure that the bench where the base plate is fastened is level, free from vibrations and is able to support the weight of the equipment in addition to the full tank load. Once the base plate is fastened in place on the bench, the melter/appliator should be mounted on top of it.

Electrical power connection

'MICRON+' series melters/appliators are designed to be connected to the electrical power supply in three possible ways, depending on the power of different elements connected:

- 1-phase 230 VAC with neutral
- 3-phases 400 VAC with neutral
- 3-phases 240 VAC without neutral

A good ground connection is required in all cases.

Consumption figures, according to melter/appliator and output configuration, are included in the table. Due to high power connected Focke Meler recommends 3-phases 400 VAC with neutral connection.



Warning: Risk of electrical shock. Carelessness may cause injury or death.

Open the electric cabinet door as far as possible. Thread the power cord (max. Ø18mm) through the electrical wall bushing (P) and fasten it to the inside anchor, making sure that the cord reaches the power card connector at the position where it will be installed.



Connect each wire in the power cord to its corresponding place on the power intake connector on the power card.

Consumption values concerning each equipment can be found in the characteristics plate.



1/N ~ 230V 50/60Hz + PE



3/N ~ 400V 50/60Hz + PE



3 ~ 230V 50/60Hz + PE

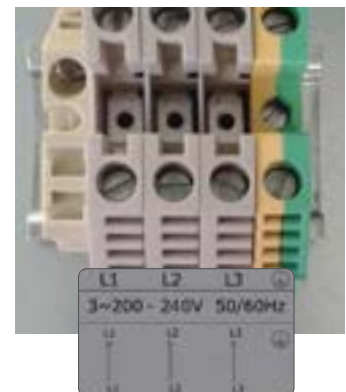

UNIT	No. OUTPUTS	1 PHASE	3 PHASES	
		230 VAC ⁽¹⁾	230 VAC Δ ⁽²⁾	400 VAC Y ⁽¹⁾
micron+ 5	2	25,65 A	18,10 A	10,00 A
	4	27,00 A (!)	26,00 A	15,65 A
	6	27,00 A (!)	38,90 A	23,48 A
micron+ 10	2	27,00 A (!)	25,90 A	14,35 A
	4	27,00 A (!)	26,00 A	15,65 A
	6	27,00 A (!)	38,90 A	23,48 A
micron+ 20	2	27,00 A (!)	29,80 A	16,52 A
	4	27,00 A (!)	29,80 A	16,52 A
	6	27,00 A (!)	38,90 A	23,48 A
micron+ 35	2	-	41,60 A	18,70 A
	4	-	41,60 A	26,52 A
	6	-	41,60 A	27,00 A (!)

Maximum connection power for each hose/appliator pair: 1,800 W

(1) **The maximum permissible current for a connection is 27 A per phase.** The table show the maximum current when using the maximum possible power. Calculate the power to be installed in each case to choose a suitable connection.

1/N~230V 1~ 50/60Hz + N + PE (Not recommended, except micron+ 5. Not available MICRON+ 35)

3/N~400V 3~ 50/60Hz + N + PE (Limited for micron+ 35)

(2) 3 ~ 230V 50/60Hz + PE (terminals connection of 10 mm²)

Pneumatic connection

Before connecting the pneumatic power to the melter/appliator, make sure the pressure regulator is completely closed. To do this, turn the regulator located on the front of the equipment next to the pressure gauge counterclockwise as far as it will go.

Connect the plant air supply (max. 6 bar) to the melter/appliator intake using flexible tubing with an outside diameter of 8 mm. The equipment is provided with a quick coupling for this purpose.

Activate the air supply to pass and turn the pressure regulator clockwise. Adjusting to 1 bar of pressure is enough for checking the pump operation.

The pump will not operate and the pressure gauge will show 0 bar until the melter/appliator and the hoses-appliators connected to it reach the correct temperature.

Once the pump operation has been checked, you may adjust the pressure to the operational value you wish.

In the pressure gauge can be found pneumatic and hydraulic pressure values, the relation between both are 1:13.6.

Warning: Do not exceed a pneumatic pressure of 6 bars under any circumstances. This may cause severe damage to the unit. Risk of projection of high-speed particles which may cause significant injury.



Hose and applicator connection

'MICRON+' series melters/applicators use standard 'meler' components. The entire range of 'classic', 'compact' and 'manual' hoses and applicators may be connected to this equipment.

Up to six hose-applicator outputs may be connected to 5, 10, 20 and 35L 'MICRON+' melters/applicators.

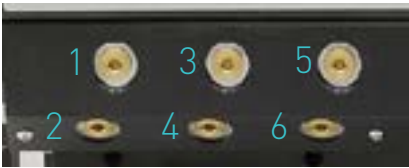

Warning: When connecting hose-applicator outputs, verify that the connected power is not above the maximum allowable power for each output.

'MICRON+' series melters/applicators are equipped with a six outputs hydraulic distributors. Connect the hoses to the distributor in order, following the numbering in the diagram.

Caution:

- In order to identify each hose-applicator, electrically connect them to the connector with the same number as the output they use.
- It is preferable to use couplings at 45° or 90° angle to minimize the space the hoses occupy. Using straight couplings usually results in curves with very small radii that may damage the inside of the hose.
- Save the screw-on caps that are removed from the distributor in order to connect a hose. They may be necessary in the future if a hose is removed from its location.
- Perform the electrical hose and applicator connections with the equipment turned off. Failing to do so may result in electrical defects in the connection and the appearance of alarm messages on the melter/applicator display.

Parameter Programming

Once the melter/applicator and its components are installed, you will need to program the operational parameters appropriate for the specific application that will be performed.

Among the various parameters, it is necessary to program the set point temperature values for each component connected and the value for overheating warnings. There are two other parameters (weekly start-up and shut-down programming and the standby temperature value) left to program in advanced systems, although the factory default values are perfectly valid for operational purposes.

Chapter "4. MELTER OPERATION" details the operating modes of the machine and its configuration.



External I/O connections

The input and output (Input/Output) signals enable the melter to communicate with the main machine simply and directly. Six I/O different signals can be used, depending on the options installed on the unit. Function of these signals can be selected by the user

The signals that can be used to communicate with the main machine are as follows:

Type ⁽¹⁾	Description	Terminal/Connector
Input	External ON/OFF A closed contact switches the unit on; an open contact turns it off.	Terminal XDI1.1 / XDI1.2 XDI2.1 / XDI2.2 ----- Connector on HMI card ⁽⁵⁾ DI3
	Standby ON/OFF A closed contact activates the 'Standby' function; an open contact deactivates it and the unit returns to the status indicated by the unit's other signals.	
	Pumping external OFF A closed contact activates pumping (if the required conditions are met); an open contact deactivates it.	
	Activity (Auto Standby - OFF) Contact for the activity control signal, to switch the unit to Standby and off mode ⁽²⁾ .	
	ON/OFF communications A closed contact activates the communications (Modbus/Profibus); an open contact deactivates them. Signals must be enabled in the unit ⁽³⁾ .	
	Reset Alarms A signal pulse reset the alarms in the equipment.	
	Inhibition of zones Zone inhibition control inputs. The unit has 8 contacts to inhibit 8 groups of programmable zones ⁽⁴⁾ . When the contact is closed, the respective group is inhibited (off); when the contact is open, the inhibition of that group is disabled (activated).	Temperature Control Board X21 (Signals 1 to 4) X9 (Signals 5 to 8)
Product passage signal (Flowmeter) Digital input to connect a photocell or product passage signal when the unit has the flow control installed ⁽⁶⁾ .	Terminal ⁽⁵⁾ X	

(1) See point '4 Use / Settings Menu / Configuration of input and output signals'.

Some inputs will not be shown on the menu, depending on which options are installed in the unit.

(2) See point '4 Use / Heating Menu / Auto Standby - OFF'.

(3) See point '4 Use / Settings Menu / Additional Settings'.

(4) See point '4 Use / Heating Menu / Inhibitions'.

(5) Connectors available according to options installed on the equipment.

(6) See point '4 Use / Flowmeter'.

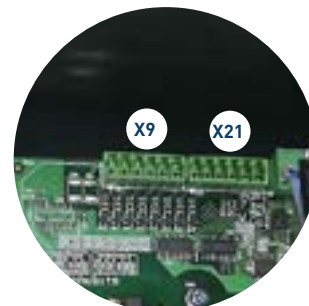
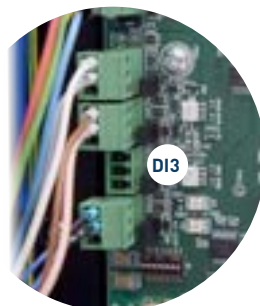
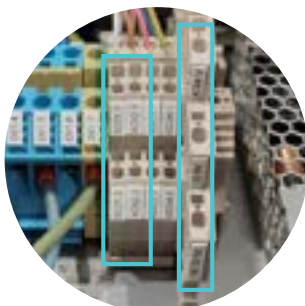

Type ⁽¹⁾	Description	Terminal/Connector
Output	<p>Standby</p> <p>Contact indicating that the unit is in STANDBY mode.</p>	<p>Terminal XD03.1 / XD03.2 XD04.1 / XD04.2</p> <p>-----</p> <p>Connector on HMI card ⁽²⁾ D02</p>
	<p>Zones Temperature OK</p> <p><u>During the heating phase:</u> contact that indicates that all of the system's temperatures have reached a level that is 3°C below its set point value (and the delay time has elapsed).</p> <p><u>During normal operation:</u> indicates that the actual temperature value is neither below nor above the programmed alarm values.</p>	
	<p>Machine Ready</p> <p>Contact indicating that the unit is in READY mode (zones with Temperature OK and no errors).</p>	
	<p>Running</p> <p>Contact indicating that the unit is in RUNNING mode (zones with Temperature OK, no errors, and pumping activated).</p>	
	<p>Alarm</p> <p>Contact indicating that the unit is in ALARM or ERROR mode.</p>	
	<p>Level</p> <p>Contact indicating that the adhesive level in the tank has reached the maximum limit.</p>	
	<p>No Level</p> <p>Contact indicating that the adhesive level in the tank has reached the minimum limit.</p>	

(1) See point '4 Use / Settings Menu / Configuration of input and output signals'.

Some outputs will not be shown on the menu, depending on which options are installed in the unit.

(2) Connectors available according to options installed on the equipment.

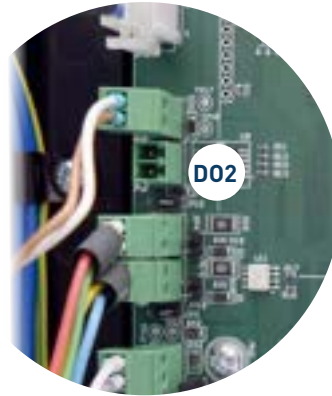

Attention: The 'Temperature OK' output **is not a contact relay** and, as such, it cannot support voltages of 230 V.

Connecting external inputs and outputs

Attention: all input/output cables must be shielded. In the melter equipment, the shield must be connected from the outside in the connector prepared for it.

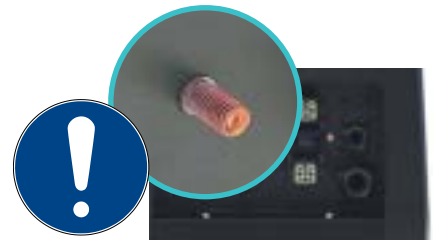

Warning: Risk of electric shock. Carelessness may cause injuries or death.

1. Disconnect the unit's power.
2. Open the front door of the electric cabinet by giving the fastening screw a 1/4 turn.

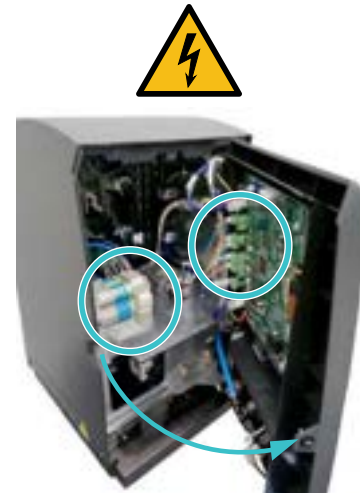

3. Run the signal cable (max. Ø14 mm) through the bushing at the rear of the unit (P) and attach it to the interior fitting, making sure the cable reaches the corresponding terminals/connectors.
4. Connect the two cable wires to the corresponding terminal/connector. The polarity of the connection must be correct:



Terminal	Polarity	Connector	Polarity
XDI 1.1	+24 VDC 200mA	DI3 1	+24 VDC 200mA
XDI 1.2	IN	DI3 2	IN
XDI 2.1	+24 VDC 200mA	DO2 1	+24 VDC 2A
XDI 2.2	IN	DO2 2	GND
XDO 3.1	+24 VDC 100mA		
XDO 3.2	OUT		
XDO 4.1	+24 VDC 100mA		
XDO 4.2	OUT		



5. Make sure that the cables are properly secured by the terminal's screws.
6. Check that the cable is correctly connected and that its passage through the electric cabinet presents no risk of jamming, being cut or any other accidental damage.
7. To assign the function to be performed by the connected signal, see point '4 Use / Settings Menu / Configuration of input and output signals'.

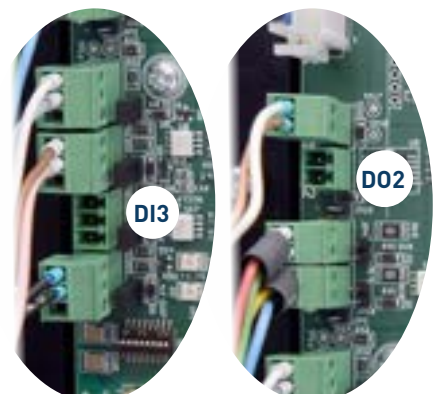

Interpretation of external inputs and outputs

The following tables show a summary of the status of each input and output signal of the unit.

Input	Connection			Description
	XDI1	XDI2	DI3	
ON/OFF	Close	Close	Close	ON
	Open	Open	Open	OFF
Standby	Close	Close	Close	Standby
	Open	Open	Open	No Standby
Pumping OFF	Close	Close	Close	No pumping
	Open	Open	Open	No Action
Activity	Close	Close	Close	Transition detected
	Open	Open	Open	Transition detected
Communications	Close	Close	Close	No Comms
	Open	Open	Open	No action
Reset Alarms	Close	Close	Close	Alarms Reset
	Open	Open	Open	No action

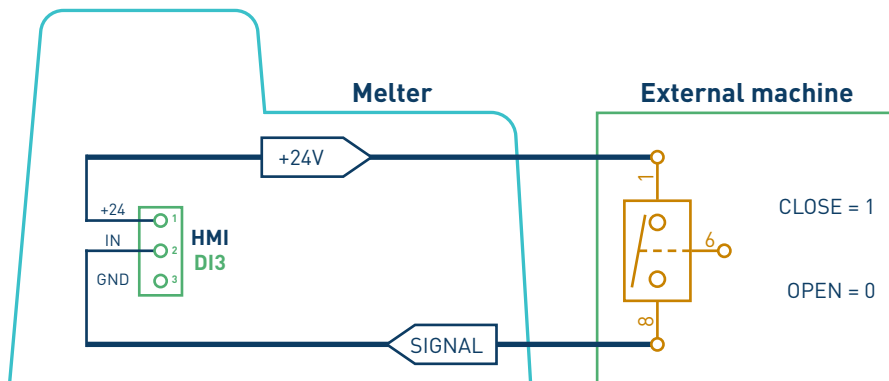
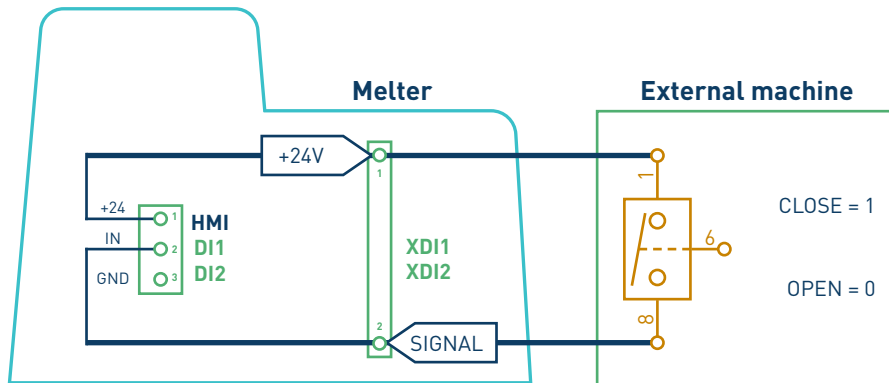

Output	Connection			Description
	D02	XD03	XD04	
StandBy	+24V	Close	Close	In "STADBY"
	GND	Open	Open	No "STANDBY"
Zones in Temperature OK	+24V	Close	Close	In " Temperature OK"
	GND	Open	Open	No " Temperature OK"
Machine Ready	+24V	Close	Close	Ready
	GND	Open	Open	No Ready
Running	+24V	Close	Close	Pumping
	GND	Open	Open	Not Pumping
Alarm	+24V	Close	Close	Alarms
	GND	Open	Open	No Alarms
Level	+24V	Close	Close	Level "OK"
	GND	Open	Open	Level "No OK"
No Level	+24V	Close	Close	Level "No OK"
	GND	Open	Open	Level "OK"

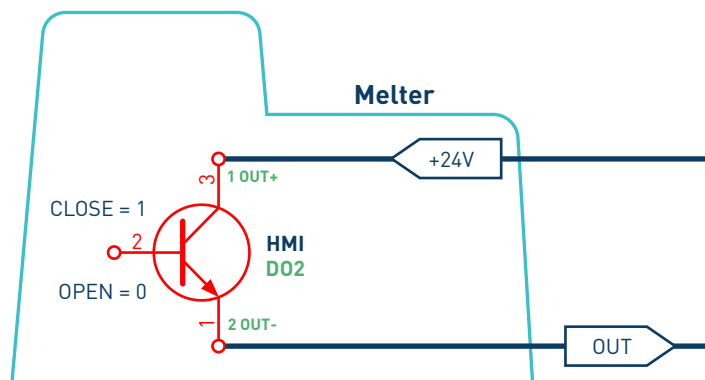
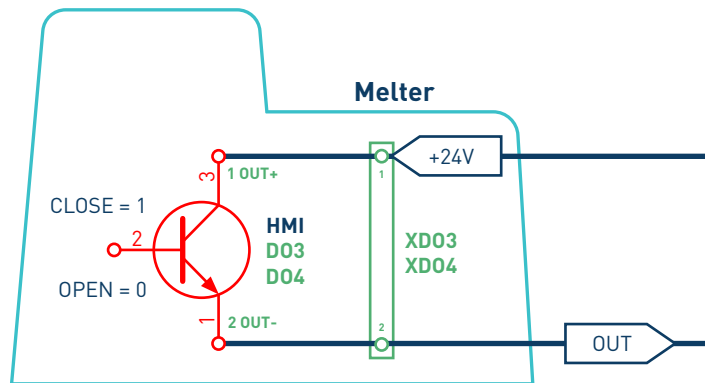

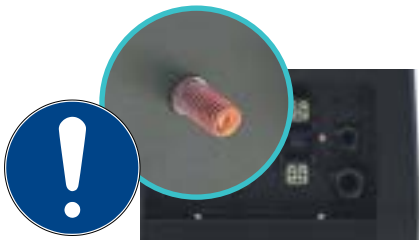

Connecting zone inhibition

Attention: all inhibition cables must be shielded. In the melter equipment, the shield must be connected from the outside in the connector prepared for it.



Warning: Risk of electric shock. Carelessness may cause injury or death.



1. Disconnect the unit's power.
2. Open the front door of the electric cabinet by giving the fastening screw a 1/4 turn.

3. Run the signal cable (max. Ø14mm) through the bushing at the rear of the unit and attach it to the interior fitting, taking care to ensure that the cable reaches the connectors (X21 / X9) in the temperature control board.
4. Remove the connectors from the board and connect the cable wires to their corresponding terminals. To activate it, all disabling signals must be switched with the GND pin.

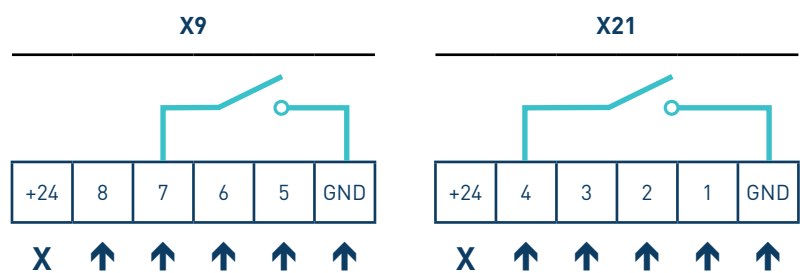
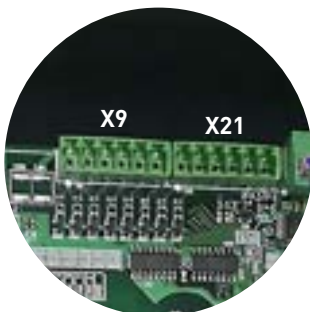

5. Reconnect the connectors to the board.
6. Check that the cable is correctly connected and that its passage through the electric cabinet presents no risk of jamming, being cut or any other accidental damage.
7. To configure the various inhibition groups and assign them the corresponding signal, see point "4 Use / Heating Menu / Inhibitions".

Connecting product passage signal (Flowmeter)

Attention: all input/output cables must be shielded. In the melter equipment, the shield must be connected from the outside in the connector prepared for it.



Warning: Risk of electric shock. Carelessness may cause injuries or death.

1. Disconnect the unit's power.
2. Open the front door of the electric cabinet by giving the fastening screw a 1/4 turn.
3. Run the signal cable (max. Ø14 mm) through the bushing at the rear of the unit (P) and attach it to the interior fitting, making sure the cable reaches the corresponding terminal (X).
4. Connect the three cable wires to the corresponding terminal. The polarity of the connection must be correct:

Terminal	Polarity	FC Color
X0V	0V	BLU
XIN	IN	BLK
X24V	+24 VDC 400mA	BRN / PNK



5. Make sure that the cables are properly secured by the terminal's screws.
6. Check that the cable is correctly connected and that its passage through the electric cabinet presents no risk of jamming, being cut or any other accidental damage.
7. To assign the function to be performed by the connected signal, see point '4 Use /Flowmeter'.

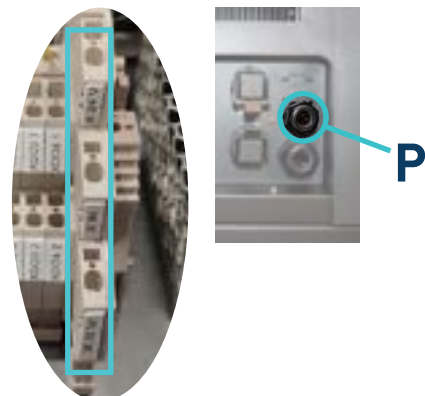

Wireless connection (Wi-Fi)

Optionally, the unit comes equipped with a wireless connection module (Wi-Fi) to connect to a local network.

To activate and configure this function, see chapter '4. Use'.



Automatic feeder assembly

Pneumatic connection

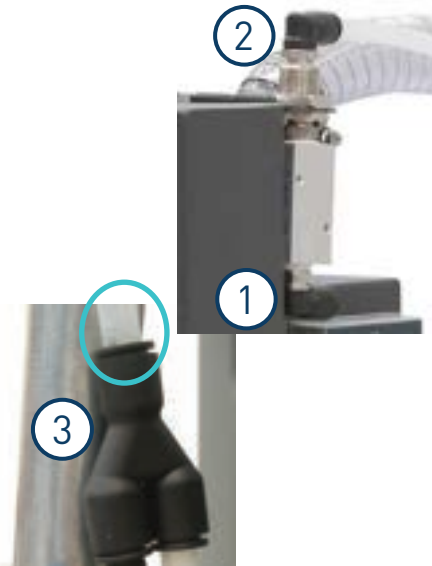

Before connecting the pneumatic power to the vacuum feeder, make sure the pressure regulator on the system and the main air supply is completely closed.

Connect the vacuum feeder through a flexible tube with outside diameter of 10 mm to the general air supply (6 bar max.) (1). The unit has a quick coupling for this connection.

The air outlet grid (2) is connected by a flexible hose outside diameter 10 mm to the Y quick connector (3) located in the area of the suction adhesive.

To be sure about the connection of the tubes in the inlet and the outlet, the valve is marked with the numbers 1 and 2 respectively. See the pictures.

Once connected, open the air supply verify that you have maximum 6 bar pressure. Pressures higher than that causes an unnecessary expense and the possibility to produce turbulences in the hot melt tank with consequent malfunction of the unit.

Suction tube connection



The suction tube should be connected to the swivel elbow of the vacuum feeder, inserting it into the inside of the metallic mouth down to its bottom.

Place the swivel elbow to the most convenient position for installation, depending on the location of the hot melt container.

Therefore:

- Loose slightly the three fixing screws for the lid of the filter and set the swivel elbow.
- Place the swivel elbow to the desired position, twisting it in the required sense.
- Tight the three fixing screws to the position of the elbow and prevent their movement.

Placing the suction tube



To transfer the adhesive from the adhesive container to the hot melt equipment, the suction tube should be inserted to the bottom of the container.

The four flaps that protects the entrance of the suction tube are designed to keep the suction mouth open and without obstructions. It maintains a free way for the suctioned adhesive.

The vibratory element (pneumatic) keeps the adhesive loose around the entrance to facilitate its suction.

The aspiration element uses compressed air. By the help of the venturi effect, a depression is created in it, that absorbs pearled and pallet adhesive and drives it to the shell of the hot-melt system.

The Venturi effect, applied to the vacuum feeder, consists in a decrease of the air pressure by an air flow inside the closed circuit while increasing the air speed when passing through the narrowing of the entry mouth.

As the entry of aspiration is connected to this point, the aspired adhesive stays in it and is transported to the hot-melt tank through the flexible communication hose.

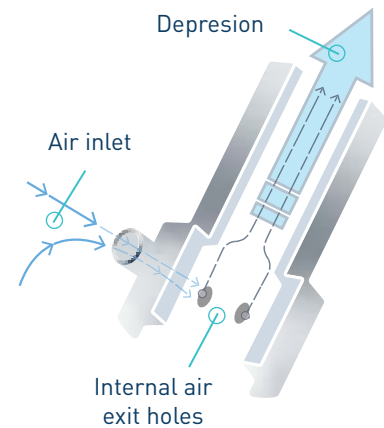

Electrical connections

Connect the power and the signal cable to the corresponding socket on the back of the equipment.



This page is intentionally left blank.

4. MELTER OPERATION

In this section we will introduce the method for using the melter. Although its operation is very simple, it should not be used by untrained personnel.

Warning: Improper use may cause damage to the machine or injury and even death to the person using it.

General information

There are three large groups of components with thermal control in a hot-melt installation: the fusion unit, the transport hoses and the applicators. All of these are controlled from the front panel of the melter equipment.

The first large group is the tank (T) and distributor (D) group and they have separate programmable controls.

The second group is the hose group. They are identified on the front panel, depending on the equipment model, by number, from number 1.1 to number 6.1. Each one has its own set point value.

The third group is the applicators group. It is identified on the front panel, depending on the equipment model, by number from number 1.2 to number 6.2. Each one has its own set point value.

The hose and applicator numbers are automatically assigned to the hose/applicator channel they are connected to on the rear part of the melter.



Filling the tank

The tank can be equipped with a low level capacitive sensor that warns when the level of hot-melt adhesive drops below a third of the tank's capacity.

The unit will deactivate the external signal and, if it is connected, will activate its the corresponding warning device.

Warning: Before refilling the tank, make sure that the adhesive is the same type as that already in the tank. Mixing different types of adhesives can cause damage to the melter equipment.





Warning: Do not fill the tank above the loading opening level.

To fill the tank:

1. Open the tank lid
2. Use a shovel or a ladle to fill the tank with adhesive. Do not fill the tank above the loading opening level. The lid must be able to close normally.

Warning: Risk of burns. Always refill using protective gloves and goggles.

Model	Capacity*	
micron+ 5	5.15 l	5.15 kg
micron+ 10	9.7 l	9.7 kg
micron+ 20	19.7 l	19.7 kg
micron+ 35	37.4 l	37.4 kg
* for density of 1g/cm ³		

3. Close the lid when you have finished refilling the tank

Manual starting up the melter equipment



Warning: Automatic start depends on the type of set-up and the installation conditions of the unit. For more information, please see the 'Turn off function after resetting' and 'Setting up the turning on and activation of pumping' sections.

Before starting up the melter equipment, it is necessary to check to see if the unit has been correctly installed and all its input/output and accessory connections are correctly established.

It is also necessary to make sure that the equipment has been filled with adhesive and that the operational parameters have been programmed.

To start:

1. Connect the melter's switch.

When the switch is actuated, the GREEN POWER LED remains lit. The unit is powered but the screen stays off.

2. When you press the ON/OFF button, the screen lights up and the POWER LED stays lit. The main screen shows the unit's status.

Once it has reached 3° below the programmed temperature (set point) of the all active elements, a programmable delay timer starts until, guaranteeing fusion, the pump receives permission to operate and the signal will be sent to the main machine by the external output 'Temperature OK'.

While the system counts down the delay time, the temperature OK symbol flashes until the programmed time value is reached. The screen displays the actual temperature values for each zone at all times.

If the temperatures of all the active zones exceed the set point temperature -3° in under 5 minutes, the unit will pass to 'Temperature OK' status without taking the 'Pumping Permission Delay' into account.



Unit status	Symbol on the display	Central LED	Description
Heating			The unit is heating the programmed zones.
Delay			The zones are at Temperature OK but the 'Pumping Permission Delay' is activated
Standby			The tank or the distributor are in standby mode.
Inhibition			The tank or the distributor are inhibited.
Warning			The unit has an operating error but can continue operating.
Alarm			The unit has an operation error and continues to operate for a programmed amount of time.
Error			The unit has an operating error and cannot continue operating.
Zones in Temperature OK			The zones are at the set point temperature.

- Use the machine's pressure gauge to make sure that the generated pressure is adequate. Values below 0.5 bar may cause erratic pump action.

Manual pumping permission

Warning: Automatic pumping permission depends on the type of set-up and the installation conditions of the unit. For more information, please see the 'Automatic pumping block function' and 'Setting up the turning on and activation of pumping' sections.

When the unit reaches the programmed operating temperature (Zones in Temperature OK), and there are no errors, the pump can be activated (READY) or disabled (STOPPED) by pressing the 'STOP' key.

When the pump is deactivated (STOPPED), the red LED next to the key stays lit.

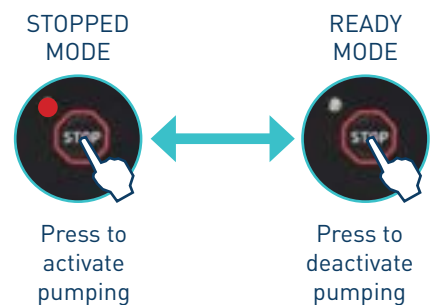

Melter equipment display

The 7-inch touchscreen shows the main data and contains a user menu to customize how your unit is configured and operated.

The user menu has the following structure:

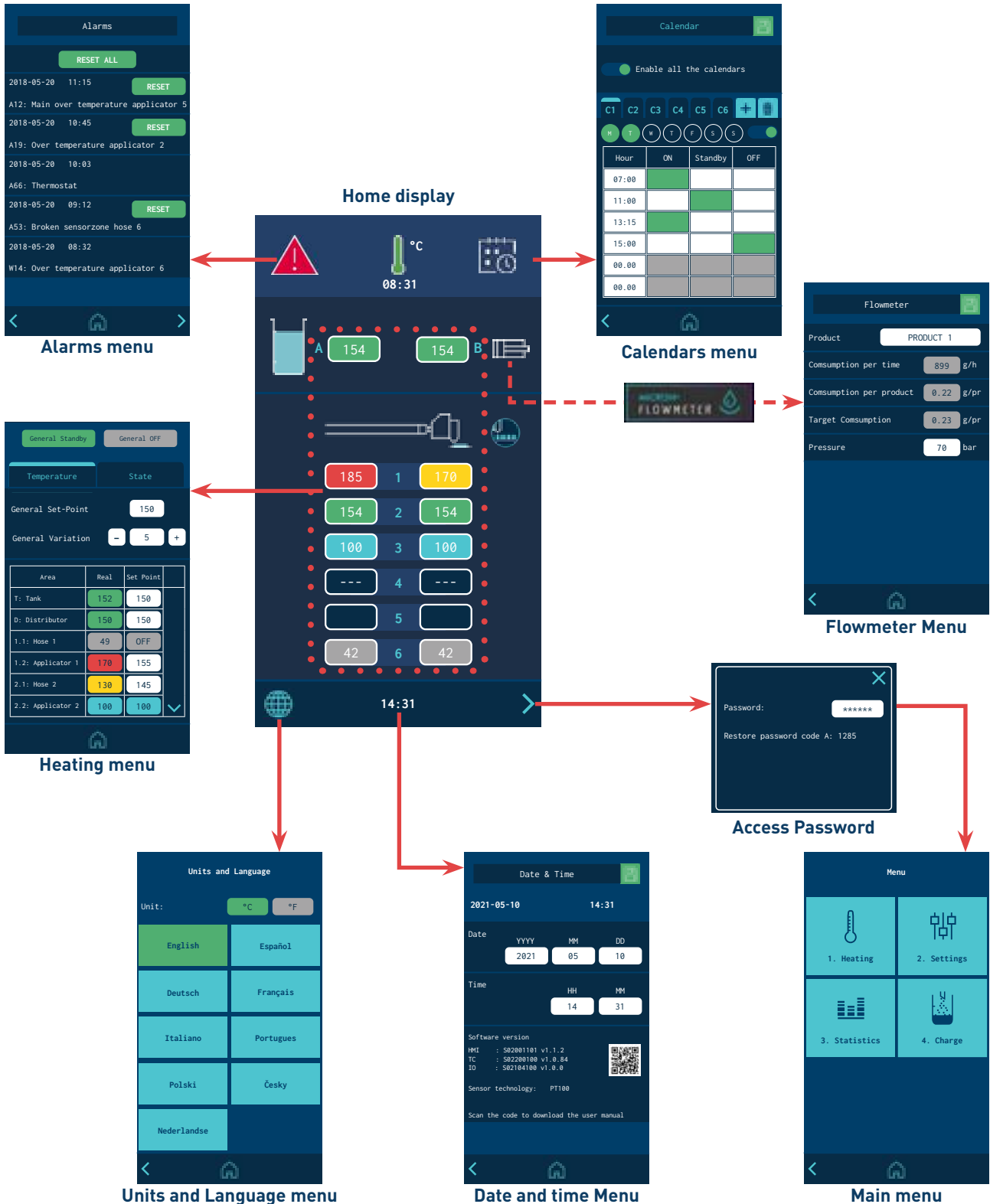

General characteristics

In general, there are several icons and pieces of information that are repeated throughout the screen navigation, so they will be explained at the beginning and then not in the next screens.

Navigation icons

Right arrow icon (FORWARD), located in the lower right part of the screen. Appears when there is a possibility of navigation to a next screen. From the HOME screen it provides access to the MENU.

Left arrow icon (BACK), located in the lower left part of the screen. This icon appears on all the menu screens, allowing you to return to the previous screen.

From any screen you can return to the main screen by clicking on the icon (HOME) located in the bottom centre of the screen.



Save changes

The 'SAVE CHANGES' icon, located in the upper right part of the screen, appears in the data entry and programming screens. If the data shown on the screen is stored, the icon appears with a blue background. If the data has not been stored, the icon is shown with a green background.

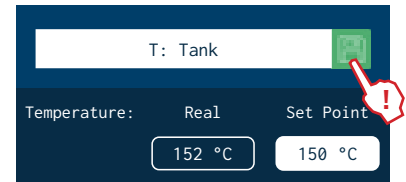

Note: In some options, the unit does not automatically store programming data. Whenever you modify or program any data that you wish to keep press "SAVE CHANGES".



Press to save



Parameters saved

Explanation of the screen contents

White: editable text.
Blue: non-editable text.

Green: press to save.
Blue: parameters saved.

White: editable parameter.
Grey: non-editable parameter.

Alphanumeric keyboard

Numeric keyboard

Green: activated.
White: deactivated.
Grey: disabled.

The diagram shows a central screenshot of the '2.2 Extra Settings' screen. It features several settings: 'Sound on alarm' (green circle), 'Screen saver' (green circle), 'Inside device temperature alarm' (green circle), 'Pumping autolock' (green circle), 'Off after reset' (green circle), and 'Modbus' (white circle). There are also input fields for '10 min', '85 °C', and '60 s'. At the bottom, there are fields for 'Node: 10' and 'B: 57600'. A green floppy disk icon with a red arrow is in the top right corner. To the left is an alphanumeric keyboard, and to the right is a numeric keyboard. Arrows point from the legend and keyboard images to the corresponding elements on the settings screen.

Home display

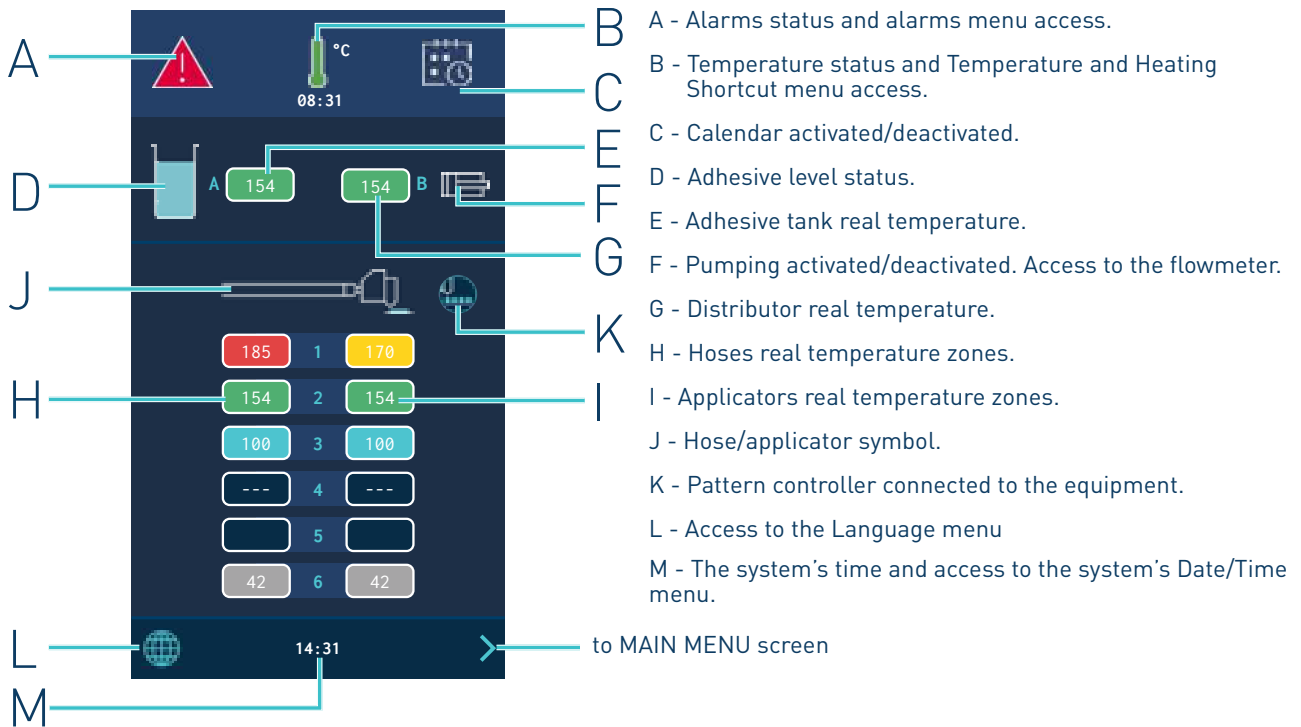

It is the main screen where the most representative values of the equipment are shown.





General temperature status

	Active zones in Temperature OK.
	Unit heating up.
	Unit heating up. 'Pumping Permission Delay' countdown timer, once all the active heated components have reached their set point temperature $\pm 3^\circ$.
	Unit in Standby mode.
	Unit in Inhibition mode.
	Unit in overheating or low temperature alarm.
Moreover, this icon shows whether the temperature is indicated in $^\circ\text{C}$ or $^\circ\text{F}$.	
Access the Temperature and Heating Shortcut displays menu by pressing the icon.	

Alarms status

	There are no errors.
	The unit has an operating error but can continue operating.
	The unit has an operating error and cannot continue operating.
Access the ALARMS menu by pressing the icon.	

Calendar status

	Calendar not activated.
	Calendar activated
Access the CALENDAR menu by pressing the icon.	

Adhesive level status

	<ul style="list-style-type: none"> • WITHOUT automatic loading • WITHOUT level sensor
---	---

	<ul style="list-style-type: none"> • WITH automatic loading • Adhesive level nearly empty
---	---

	<ul style="list-style-type: none"> • WITHOUT automatic loading • WITH level sensor. Adhesive level nearly empty
---	---

	<ul style="list-style-type: none"> • WITH automatic loading • Adhesive level nearly empty and LOADING
---	---

	<ul style="list-style-type: none"> • WITH automatic loading • Adhesive level sufficient and LOADING (extra time)
---	--

	<ul style="list-style-type: none"> • WITHOUT automatic loading • WITH level sensor. Adhesive level sufficient
---	---

	<ul style="list-style-type: none"> • WITH automatic loading • Adhesive level sufficient
---	---

Pumping status

	Pumping not activated.
	Pumping activated.
Click on the icon to go to the Flowmeter menu (optional).	

Temperature status

	Zone heating.
	There is no physical connection of components in that zone.
	Temperature sensor error in that zone.
	Zone in Temperature OK.
	Zone in Standby mode.
	Zone in Inhibition mode (OFF).
	Zone in overheating or low temperature warning. Note: For a zone to be able to give a low temperature warning, it must have first reached its set point temperature.
	Zone in overheating or low temperature alarm. Note: For a zone to be able to give a low temperature warning, it must have first reached its set point temperature.
Access the SHORTCUTS menu by pressing the temperatures area.	

Temperature and Heating Shortcut displays

These screens give you access to the unit's quick settings.

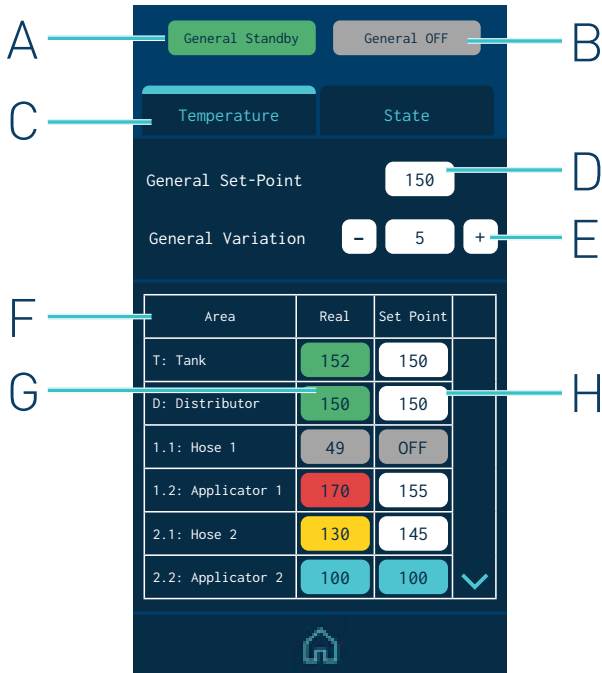

A - General standby of the unit (activate/deactivate).

B - General inhibition of the unit (activate/deactivate).

C - Programming of temperatures.

D - General set point temperature (all zones).

E - Temperature variation over the set point.

F - Temperature zones (14 zones).

G - Actual temperature.

H - Set point or control temperature.

- Unit ON: Setpoint temperature.
- Unit or Component on Standby: Standby Temperature.
- Component Disabled: OFF

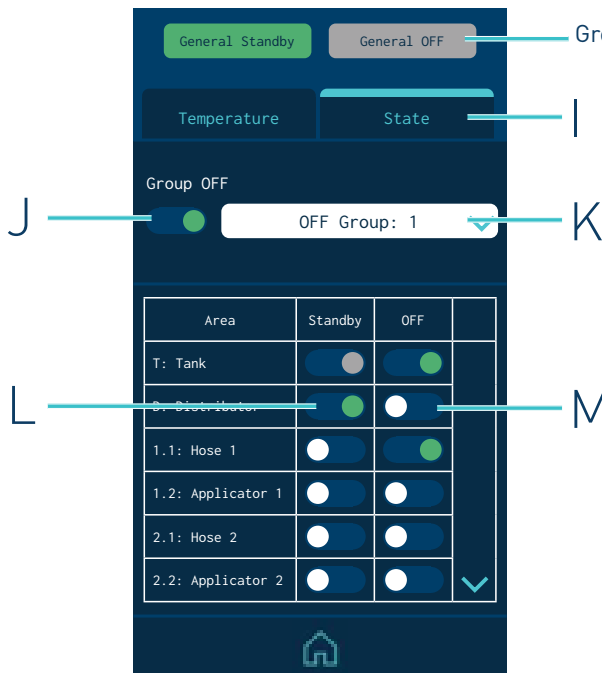

Green: activated. Grey: deactivated

I - Programming of zone statuses.

J - Inhibition/activation by groups of zones.

K - Group selection.

L - Activation of Standby in each zone.

M - Activation of Inhibition in each zone.

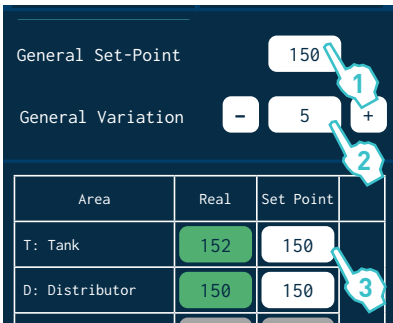

Programming of temperatures

1. Enter a temperature in 'General set point' to simultaneously program all the zones with that temperature value.
2. To make quick adjustments, enter a variation value in 'General variation' and add (+) or subtract (-) it from the 'General set point' value. The value is simultaneously added or subtracted in all zones.
3. To program each zone individually, click on the 'Set point' value and enter the new desired temperature value.

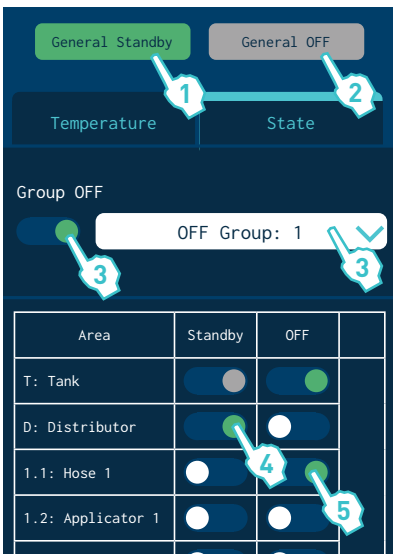

Programming of statuses

Press 'General Standby' to activate (green) or deactivate (grey) the Standby mode in all zones.

With the 'General Standby' mode activated (Equipment in Standby) it is not possible to activate each Zone individually.

4. Press 'General Off' to activate (green) or deactivate (grey) the Inhibition in all zones.

With the 'General Off' mode activated (Equipment OFF) it is not possible to activate each Zone individually.

5. To inhibit a group of zones, select the group and activate the inhibition (green). To define the different groups, see the 'Inhibitions' point.
6. Press 'Standby' in each zone to individually activate (green) or deactivate (white) the Standby mode.
7. Press 'OFF' in each zone to individually activate (green) or deactivate (white) the inhibition.

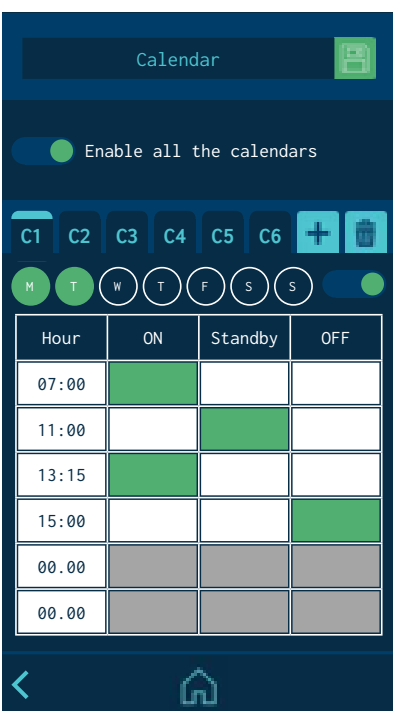

Calendar

This menu allows you to program a calendar with the unit's status changes. Once it is activated, the unit changes from one status to another automatically.

When the unit is switched on, it does so in the mode that has been programmed in the calendar, if the calendar is activated.

You can create up to six calendars (C1, C2, etc.) and up to six status changes per day, indicating whether the unit will be in ON, Standby or Inhibition (Off).

From the 'Select all calendars' option, you can simultaneously activate or deactivate all the calendars you have created.

You can add different days of the week to each calendar. Keep in mind that a single day cannot be programmed in two active calendars. Therefore, if a day of the week is programmed in an active calendar, it can only appear in other calendars if they are disabled.

Units and Language Menu

- **Units:** To select whether the temperatures are displayed in °C/°F.
- **Language configuration:** Press the desired language.

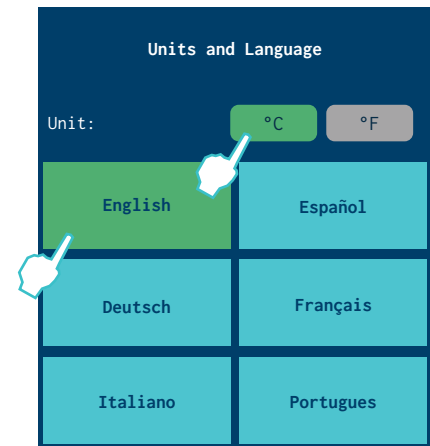

Date and time configuration

This screen allows you to view and modify the date and time data of the system.

It also shows:

- The equipment software version.
- A QR code, to be able to download the user manual.
- The type of technology of the installed sensors.



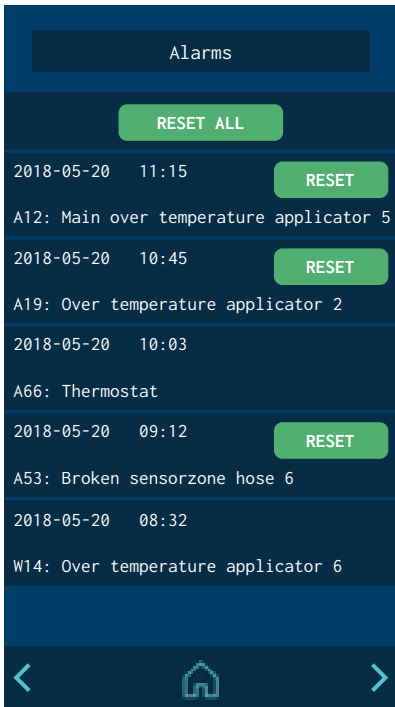

Alarms and warnings

It displays the alarms and warnings in chronological order. It shows 5 alarms on each screen, with a total of 3 screens.

When an alarm/warning needs to be reset for the unit to return to operation, a button appears for you to press and confirm that the problem has been resolved. Through the external signal 'Alarm Reset' it is also possible to carry out this operation.

The 'Reset All' button appears on the screen to delete all the alarm/warning logs.

Main Menu

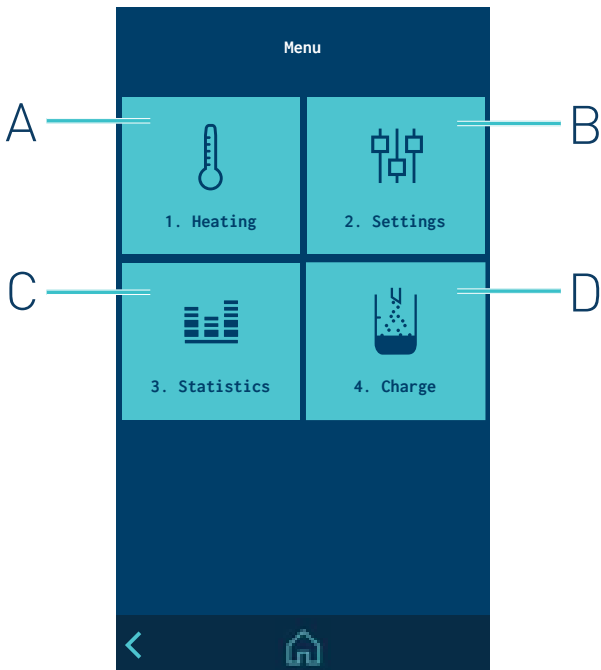

A - Heating options configuration.

B - General settings of the unit.

C - Access to statistics.

D - Automatic loading configuration.

'1. Heating' Menu

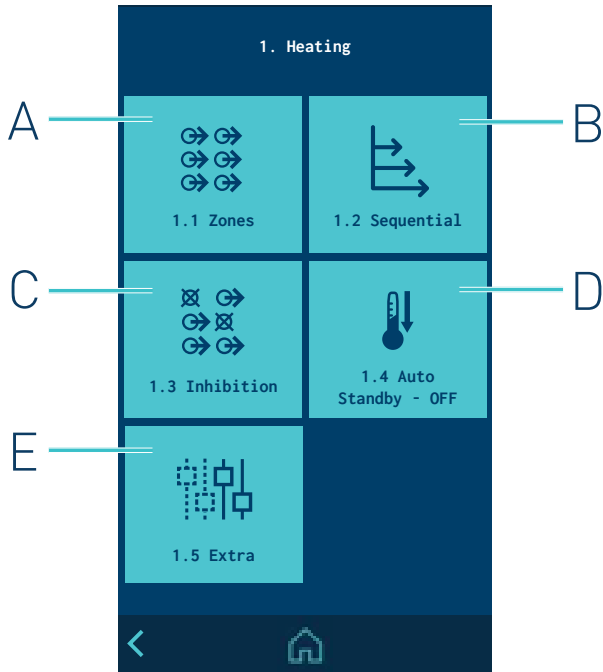

A - Heating zones configuration.

B - Heating sequence by zones configuration.

C - Programming of Inhibitions.

D - Standby modes configuration.

E - Access to extra options.

1.1 Heating zones

This menu lets you do the following for each zone:

- Change the name to identify it more easily.
- Edit the set point temperature.
- Edit the standby value. The value indicates the temperature reduction with respect to its set point.
- Apply PID values. By default the unit comes configured with a Standard PID.

You can select from four PID options: Standard, Moderate, Quick or Manual.



Note. The PID values are directly involved in the heating process. Do not modify these values if you do not have the required technical knowledge or without the advice of Meler's After Sales Service.

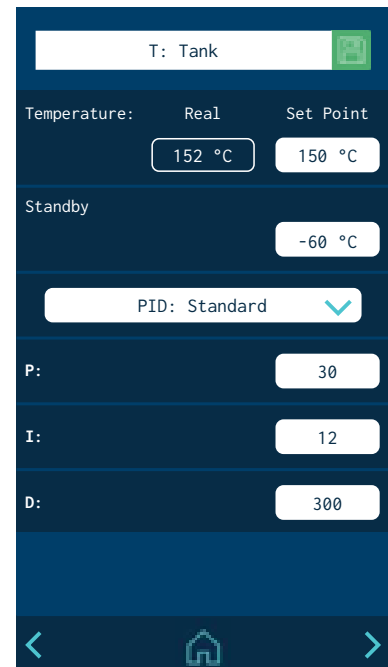

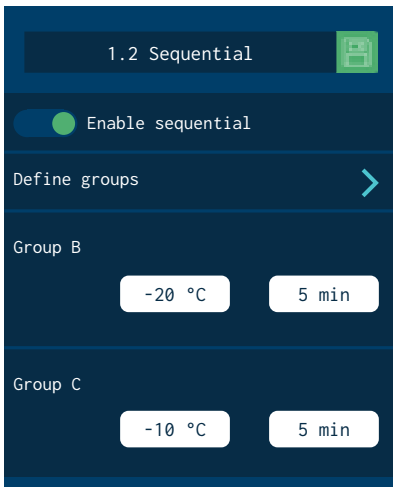

1.2 Sequential Heating

This lets you start heating the zones one after the other. This prevents a zone from being active for a long time until the slowest zone heats up.

This function allows you to create three heating groups: A, B and C. Press 'Define groups' to go to a screen where zones can be added to the groups:

- **Group A:** this always includes the Tank, which is the slowest and serves as a reference for the remainder of the zones. Other zones can be added so they begin to heat up with the Tank.
- **Group B:** other zones can be added and some degrees of temperature defined before the tank reaches its set point and a wait time.
- **Group C:** the zones that are not in group A or B can be added here.

If a component in group B or C is deselected, it goes back to group A. By default, all the zones belong to group A.

Example:

- Tank set point temperature: 150°C
- Programming of Group B: -20°C / 5 minutes.

Group B begins to heat up 5 minutes after the tank reaches 130°C.

1.3 Inhibitions

This menu allows you to create seven groups of zones and program the mode in which the Inhibition (Off) can be activated or disabled.

The following is indicated for each group:

- **Name of the group.** The name can be changed to identify it more easily.
- **Manual inhibition of the group (Manual Off).** Whether it is possible to manually activate or deactivate the inhibition in that group from the 'SHORTCUTS' menu.

Manual inhibition takes priority over external inhibition.

- **Automatic inhibition with external signal (External Off).** Whether it is possible to externally activate or deactivate the inhibition in that group. You must indicate which of the seven possible external signals will perform this function.

One signal can never be enabled in two different groups.

- **Selected zones.** A zone may be selected in more than one group or may not be in any group.

1.4 Auto Standby - OFF

This function can program the following work parameters:

- **Standby Deactivation:** automatically deactivates the ‘General Standby’ mode activated manually. Once the minutes programmed in the unit have passed, the heating process will start again.

If the ‘Calendar’ is active, the unit will follow the programmed calendar.

- **Activity control:** This lets you configure the times for changing to Standby mode and to Inhibition (OFF) when the activity signal ceases.

The activity of the line is monitored from a digital input. When it detects that there is no activity, the unit changes to Standby mode after the programmed time has passed, and changes to Inhibition mode when the second time has passed.

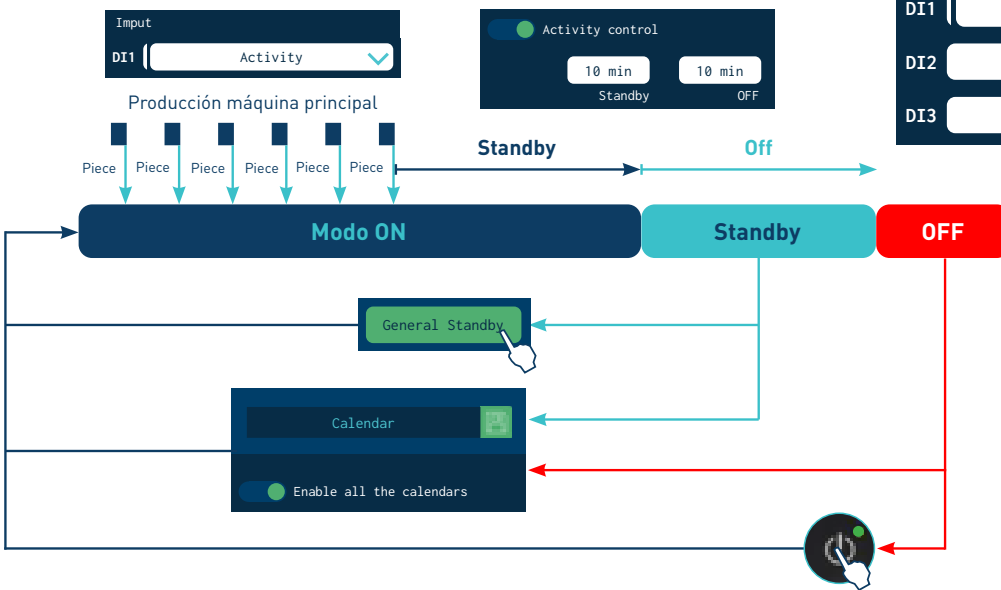
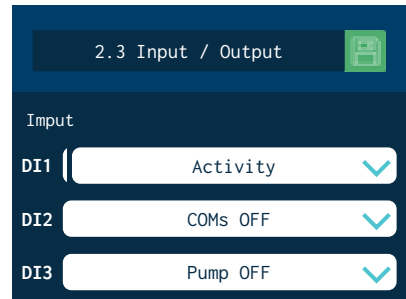

- **Standby due to no reload:** the unit automatically goes into Standby when it detects a lack of adhesive and has not detected a reload after the programmed time has passed.

1.5 Heating Extra settings

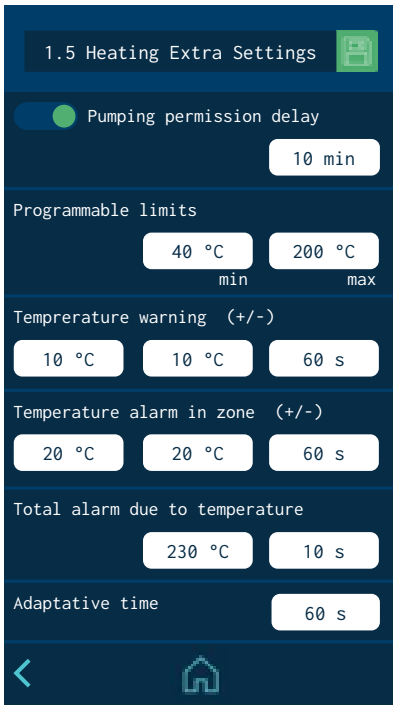

- **Pumping permission delay:** This is the time that the unit must wait to activate pumping after all the active zones have reached a temperature above [Set point temp. -3°].
 - **Programmable limits:** Two limits can be set to prevent set point temperatures from being programmed above or below those values.
 - **Temperature warning:** A temperate (±°C/°F) and a time are defined to indicate when the overheating or low temperature warning is activated in each zone.
 - **Temperature alarm:** A temperature (±°C/°F) and a time are defined to indicate when the overheating or low temperature alarm is activated in each zone.
- If either of those values are reached (±) and maintained for the set time, the unit disconnects the heating in the zone causing the error. If the error persists 3 minutes later, the remainder of the zones are automatically disconnected. If the affected zones are the tank or the distributor, the unit also stops the pumping.
- **Total temperature alarm:** A temperature (±°C/°F) and a time are defined to indicate when the overheating alarm is activated. If any zone reaches this temperature and maintains it for the set time, the unit disconnects the heating of all zones and stops the pumping.
 - **Adaptive time:** Automatic interval setting for warning and alarm temperatures, when the user reprogrammes the setpoint values.

(*) Example values

Status	Actual temperature*	Set point temperature*	Heating	Pumping	OUTPUTS		
					Temp.OK zones	Alarm Activated	Ready / Running
	150	150	ON	ON	ON	OFF	ON / OFF
	140	150	ON	ON	ON	ON	ON / OFF
	160						
	130	150	OFF Unit	OFF when... Error in Tank Error in Distributor	OFF	ON	ON/OFF
	170		OFF Zone in error	ON when... Error in the remainder of the Zones OFF when... 3' in error			
	190	150	OFF All Zones	OFF			

'2. Extra settings' Menu

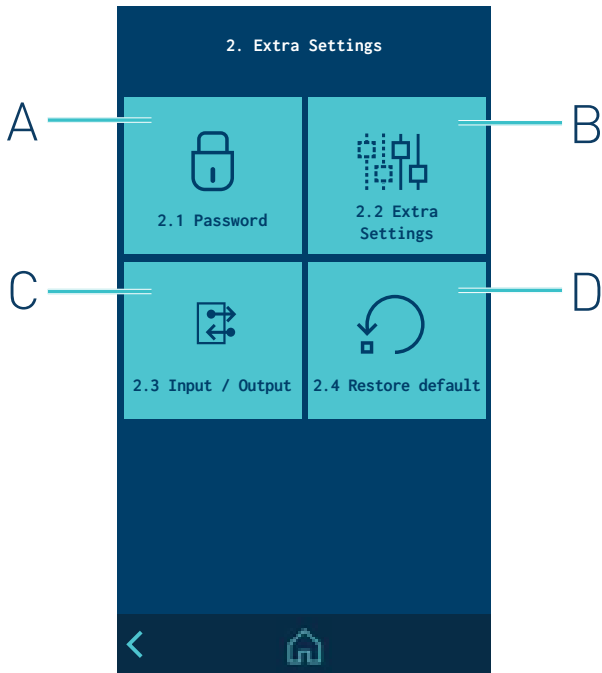

A - Password management.

B - Extra settings.

C - Configuration of input and output signals.

D - System restore.

2.1 Password management

LOCKED MODE:

- Access is only provided to the HOME screen.

USER MODE:

- no parameter can be changed. There is direct access to the HOME screen and shortcuts
- by default, the user level has no password. You can create a user level password by entering a value between 0000 and 9999

EXPERT MODE:

- Any parameter can be changed after entering a 4-digit password. By default the password is 0000.
- Direct access is provided to the HOME screen, to shortcuts and the MAIN MENU for programming
- The expert level password can be changed by entering a value between 0000 and 9999.
- USER or EXPERT operating mode can be selected or LOCKED.

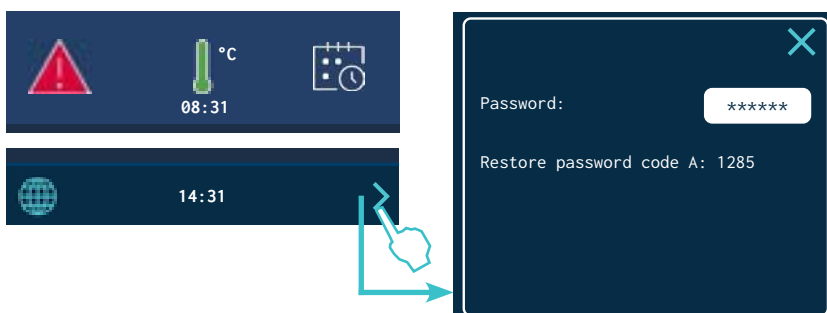
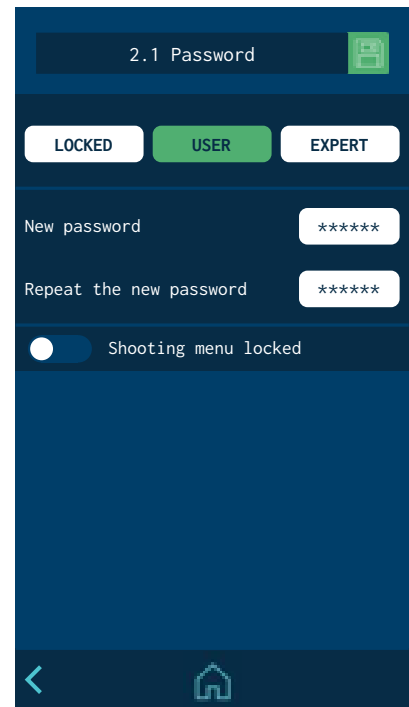



If you try to access a restricted menu, a pop-up appears, requesting the password.

If the EXPERT password is entered, the unit remains unlocked for 15 minutes. Whenever there is activity on the screen, the system remains in this mode. If the end of this 15 minutes is reached, the unit returns to USER mode.

If you forget the EXPERT level password, contact the Focke Meler main offices to find out how to proceed to recover it.

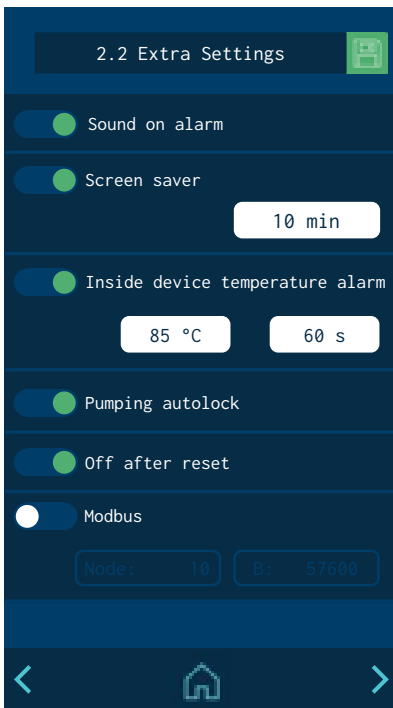

2.2 Extra settings

- **Activate or deactivate the alarm sound.** To stop the sound, press the ALARM icon on the HOME screen.
- **Activate or deactivate the screensaver.** The screen switches off after the set time has passed. If you press the screen when it is off, it turns on and the HOME menu appears.
- **Cabinet temperature alarm:** A value (+°C/°F) and a time are defined to indicate when the alarm is activated due to overheating inside the unit's electrical cabinet. If it reaches this temperature and maintains it for the set time, the unit disconnects the heating of all zones and stops the pumping.
- **Automatic pumping block.** Please see the 'Automatic pumping block function' section.
- **Turning off after resetting.** Please see the 'Turning off after resetting function' section.
- **Modbus.** Activate and disable external communications via Modbus.

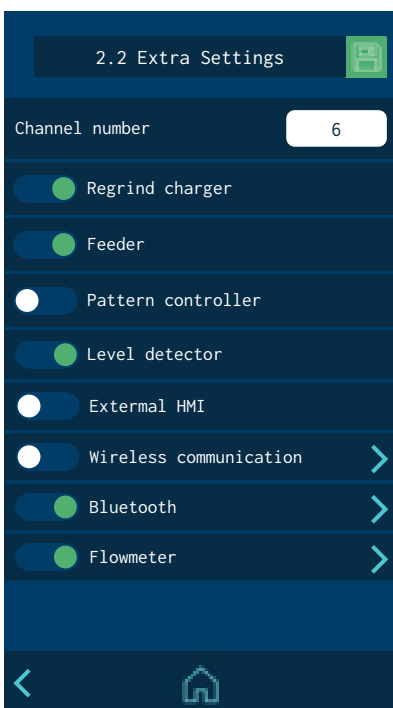

- **Number of channels.** Set up the number of electrical outputs enabled in the melter.
- **Automatic feeder.** Activate or disable the operation of the automatic feeder.
- **Feeder.** Activate or disable the operation of the external adhesive feed (external liquid load or pellet level).
- **Pattern controller.** Activate or disable the pattern controller functions.
- **Level sensor.** Activate or disable the operation of the level sensor.
- **External HMI.** Activate or disable the operation of the external HMI control.
- **Wireless communications.** You can enable or disable the operation of the unit's wireless communication system (Wi-Fi). Click on the arrow to go to the configuration screen. See the point on 'Wireless communications' for further information.
- **Bluetooth.** Activate or disable the Bluetooth function.

Click on the arrow to go to the configuration screen. See the point on 'Bluetooth connection Annex' for further information.

- **Flowmeter.** Activate or disable the adhesive flow control function.

Click on the arrow to go to the configuration screen. See the point on 'Flowmeter' for further information.

2.3 Configuration of input and output signals

This allows you to configure the unit's digital input and output signals.

The inputs can be:

- **ON/OFF:** Switches the unit fully off or on.
- **Standby:** Activates or deactivates the Standby mode.
- **Activity:** Enables the activity control to measure the times for switching automatically to Standby and OFF.
- **Pump OFF:** Activates or deactivates the pumping.
- **COMs OFF.:** Activates or deactivates the communications.
- **Reset Alarms.** Resets the alarms on the equipment.

The outputs can be:

- **Standby:** Indicates that the unit is in Standby mode.
- **Zones in Temperature OK.** Indicates that all active zones are in temperature OK.
- **Machine Ready.** Indicates that the unit is ready to operate, with temperature OK and no operating errors.
- **Running.** The unit is pumping, with temperature OK and no operating errors.
- **Alarm:** Indicates that there is an active Alarm.
- **Level:** Indicates high level of adhesive in the tank.
- **No Level:** Indicates low level of adhesive in the tank.

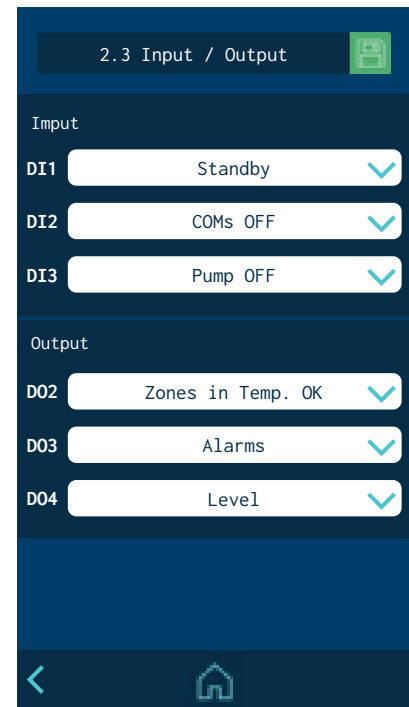

2.4 Restore default values

Allows you to delete all the changes made to the system and leave the unit with the factory-set default parameters. After pressing, the following confirmation message will appear.

When you press 'YES', the device restarts with the default configuration.

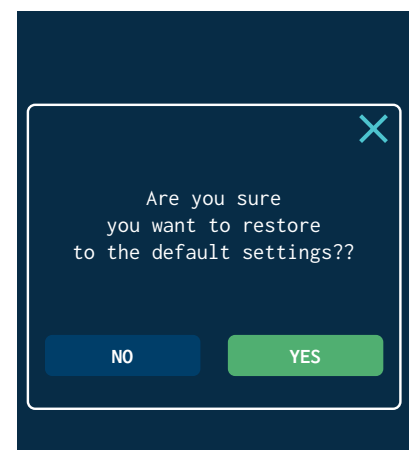

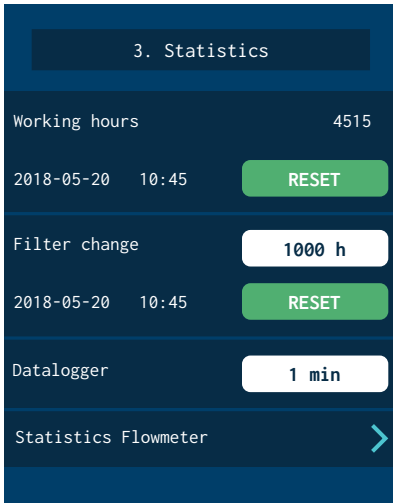

'3. Statistics' Menu

This screen displays:

- **Hours of operation:** This counts all of the hours during which the unit is in Temperature OK.
To reset the counter to zero, you must press reset.
- **Filter change.** To program a countdown in hours. When it gets to '0', the unit gives a warning to change the adhesive particles filter.
Once the filter has been changed, press reset to return the counter to the set value.
- **Data logger.** Time interval for logging the unit's programming and operating data.

You can back up this data using the application for PCs.

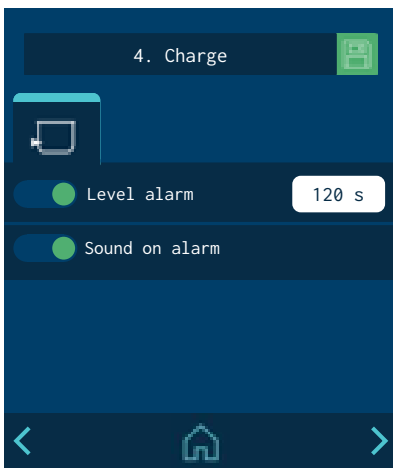

'4. Load' Menu

This screen allows you to control the different issues related to adhesive loading.

Screen 1: Minimum adhesive level sensor

- **Level alarm.** Time after which the unit stops and activates a low-level alarm.
- **Sound with alarm:** Allows you to configure the sensor alarm to emit a sound.

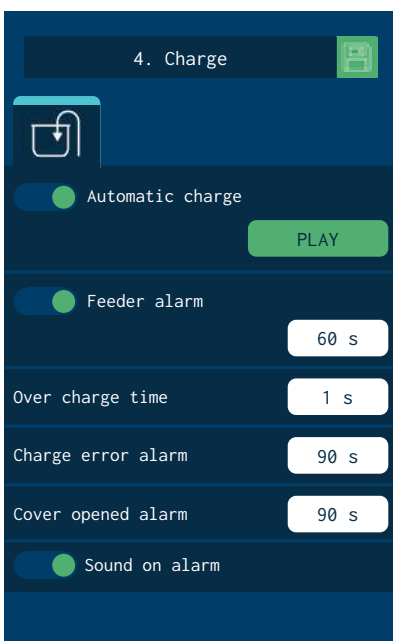

Screen 2: Automatic adhesive feeder

- **Automatic feeder.** Activates or deactivates automatic feeding.
When you press 'CHARGE', This lets you activate manual loading. When pressed, it loads, and when released, the loading stops.
- **Feeder alarm.** Defines the time that must pass to give an external feed alarm.
- **Overfill time:** This lets you configure for how much time the adhesive will continue to be loaded once the lower level sensor has activated (tank sufficiently full, but not completely full).
- **Loading error alarm:** This defines the maximum amount of time for filling the tank. If this time is exceeded, the unit displays an alarm.
- **Open tank lid alarm:** An alarm sounds when the tank lid is open and it stops loading immediately.
- **Buzzer:** This lets you set whether or not loading alarms emit a sound.

Automatic pumping block function

The unit has a function for to automatically block pumping due to a voltage drop, a direct disconnection from the network, or an operating error.

This function can be activated or disabled via the “2. Extra settings / 2.2 Extra settings” screen.

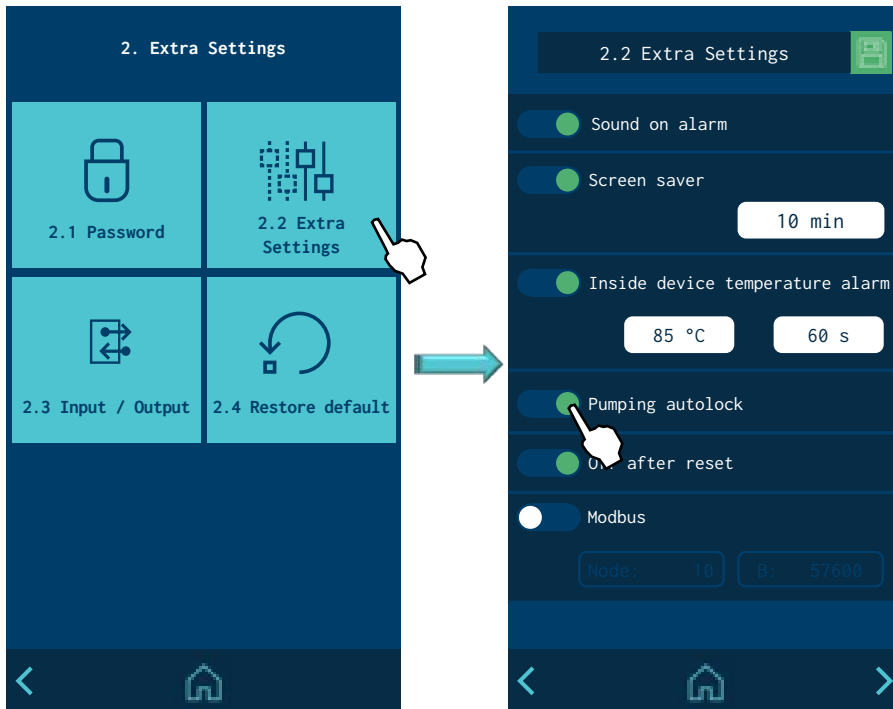

'Automatic pumping block' enabled

When this function is enabled, whenever an event forces the unit to change to ERROR mode, STANDBY mode or OFF mode, the pumping block is automatically enabled, and the STOP button's red LED lights up.

If conditions allow the unit to return to READY mode, the block can be disabled by pressing the STOP button. The red LED turns off, and the unit stays in READY mode.

Example: The unit is in RUNNING mode. At this moment, the temperature is not OK, and after the programmed time has passed, the unit changes to ERROR mode. The pumping block is automatically enabled, and the red LED lights up. The pumping block cannot be disabled while the temperature is not OK, and the error continues to be displayed. When the temperature is OK again, the unit does not automatically change to READY mode. You must press STOP to disable the pumping block and prepare the unit for pumping.

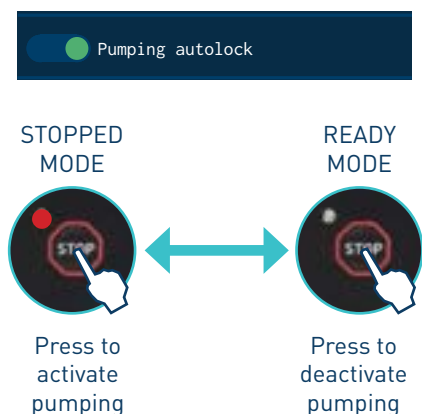

'Automatic pumping block' disabled

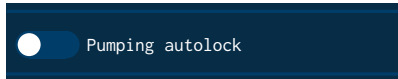

When this function is disabled, whenever an event forces the unit to change to ERROR mode, STANDBY mode or OFF mode, it will automatically return to READY mode once the conditions are met again. You do not have to press STOP. The red LED will remain off.

Example: The unit is in RUNNING mode. At this moment, the temperature is not OK, and after the programmed time has passed, the unit changes to ERROR mode. When the temperature is OK again, the unit automatically changes to READY mode.

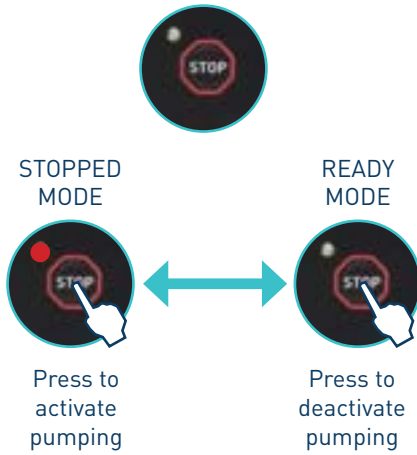

Warning: It is always possible to put the unit in STOPPED mode by pressing STOP. The red LED will light up. In this case, even if permitted by the conditions, it will not be possible to return to READY mode until you press STOP again and the LED turns off.



Warning: Whenever the 'Automatic pumping block' function is disabled, it is recommended for the 'ON/OFF' or 'OFF Pumping' signal of the unit to be connected to the main machine, so that this signal can be used to enable the unit again in a controlled manner.

'Off after reset' function

The unit has a function to recover its current status (ON/OFF) after a voltage drop or a direct disconnection from the network.

'Reset' means turning off and turning on the unit using any main ON/OFF switch or any loss and recovery of power.

This function can be activated or disabled via the "2. 2. Extra settings / 2.2 Extra settings" screen.

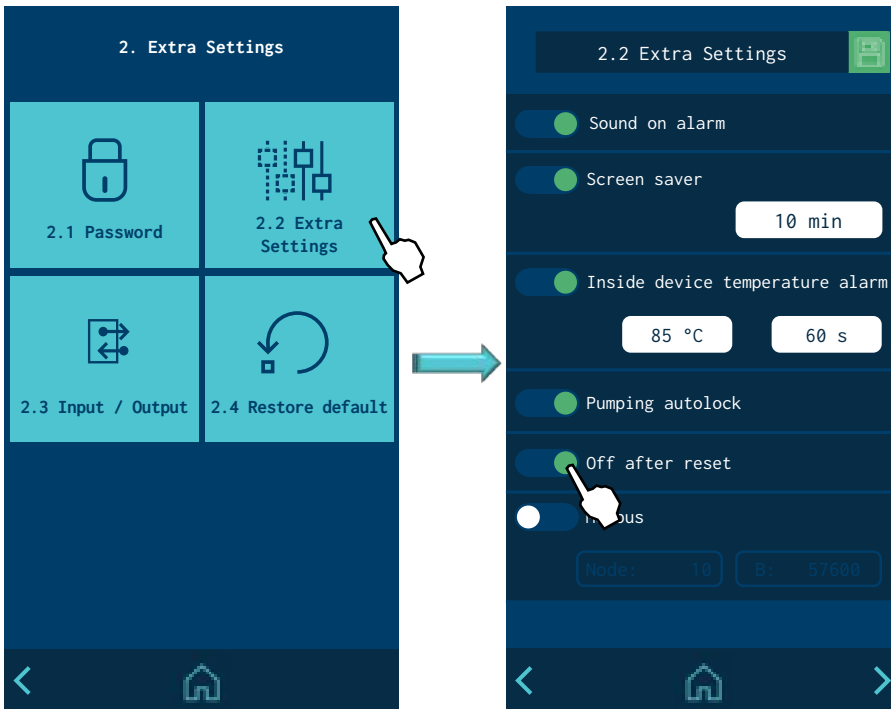

'Off after reset' enabled

When this function is enabled, whenever a 'reset' occurs, the unit remains in OFF mode and the screen is turned off.

The unit can be turned on (ON) through:

- External "ON/OFF" contact (if installed and enabled),
- or external communications (if installed and enabled),
- or the Calendar function (if programmed and enabled),
- or by pressing the "ON/OFF" button on the front screen,

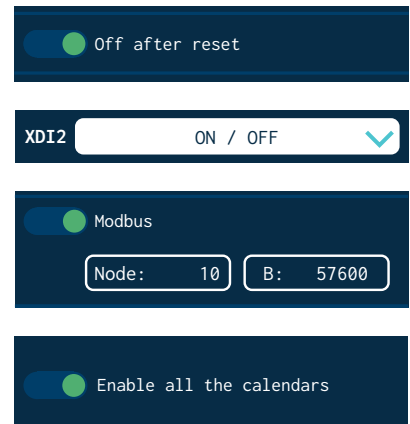

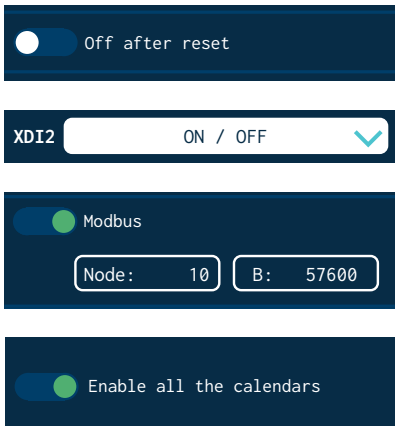

'Off after reset' disabled

When this function is disabled, whenever a 'reset' occurs, the unit recovers the ON/OFF status that it was in at that time.

The unit can change status through:

- External "ON/OFF" contact (if installed and enabled),
- or external communications (if installed and enabled),
- or the Calendar function (if programmed and enabled),
- or by pressing the "ON/OFF" button on the front screen,



Important: if the unit is in ERROR mode when the 'reset' occurs, it will remain OFF, even if the function is disabled.

Initial status	After a "reset" the equipment status will be::	
	Function enabled	Function disabled
Equipment OFF (Screen off)	Equipment OFF	Equipment OFF
Equipment ON (Screen on)	Equipment OFF	Equipment ON
Equipment in ERROR (Screen on)	Equipment OFF	Equipment OFF

Configuration of turning on and activating pumping

These are different possible pump turn on and activation modes depending on the installation and programming of the unit.



The following images provide a simplified example of the most typical sequences for turning on and activating the pumping. The unit status changes may change by pressing the 'ON/OFF' or 'STOP' buttons, or through external input signals, communications (ModBus, Profibus, etc.), programming states or operating errors:

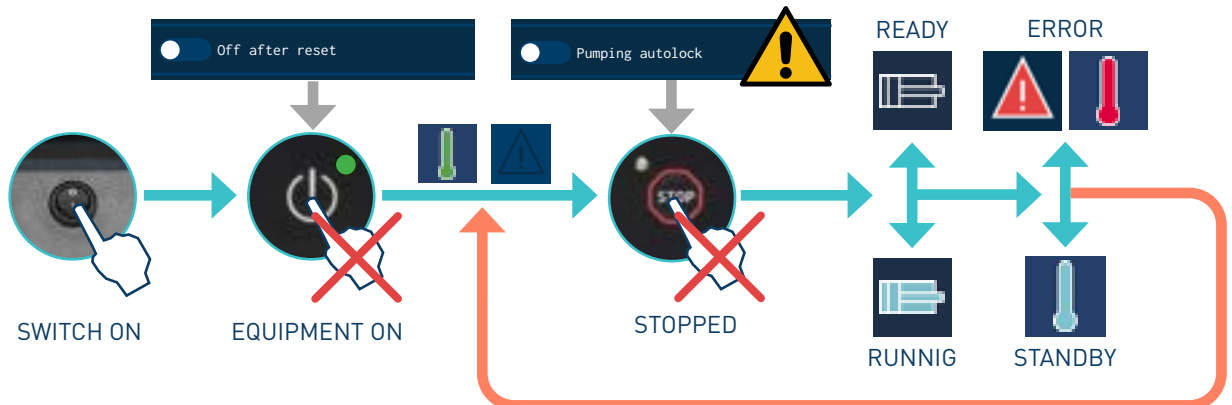
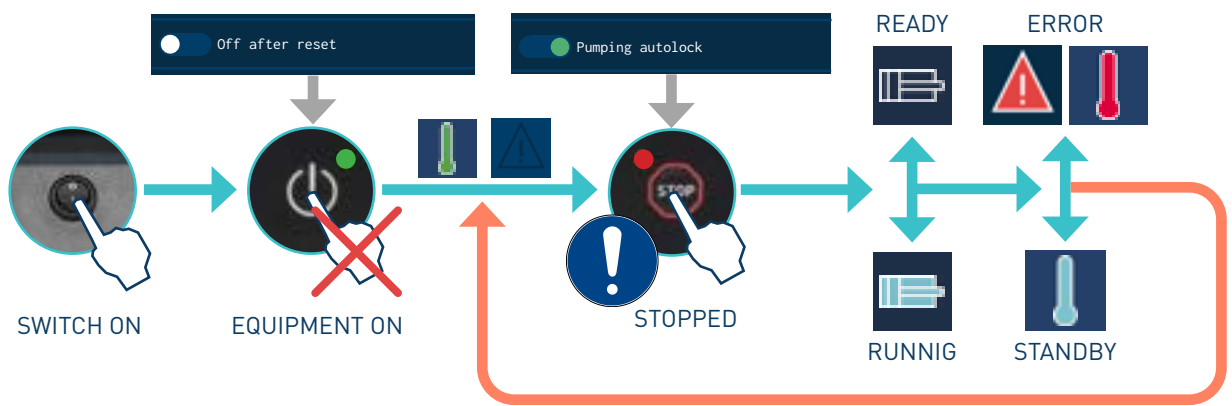
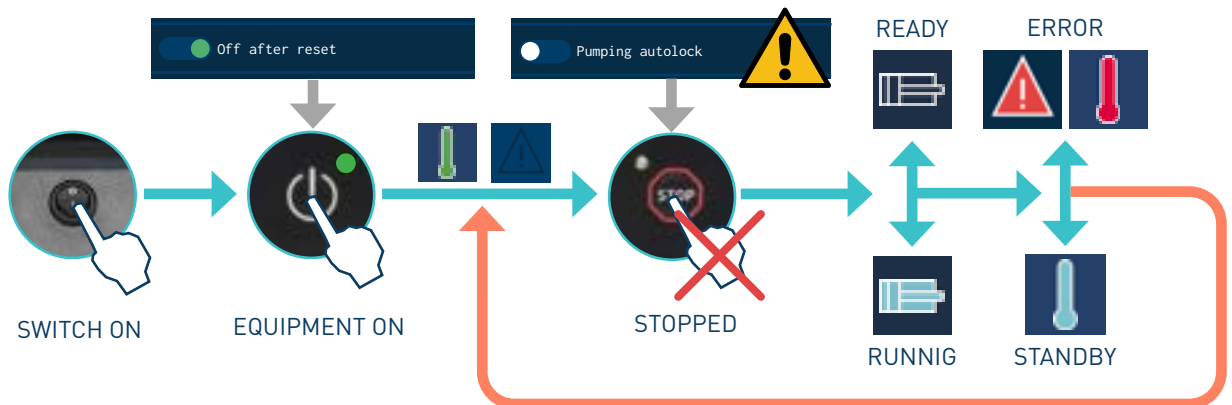
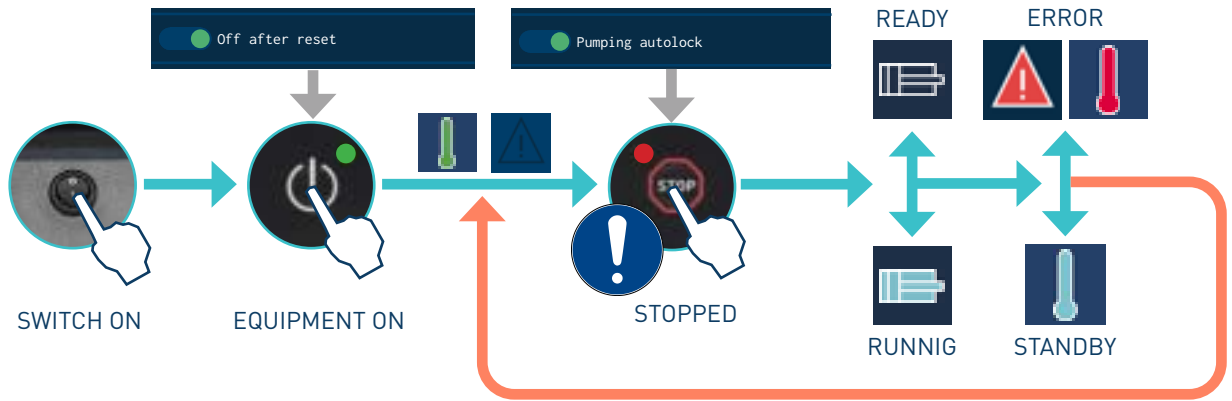

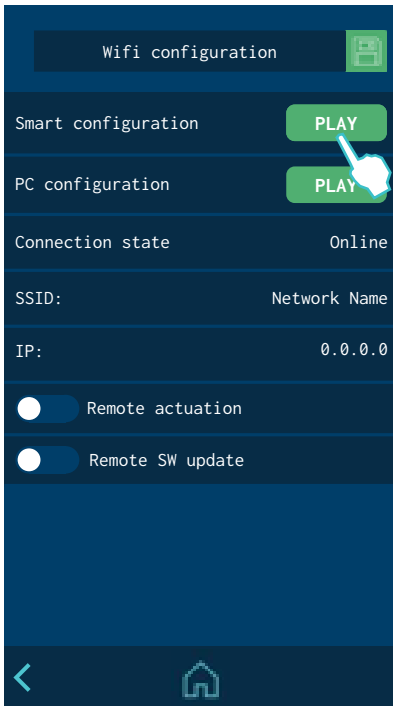
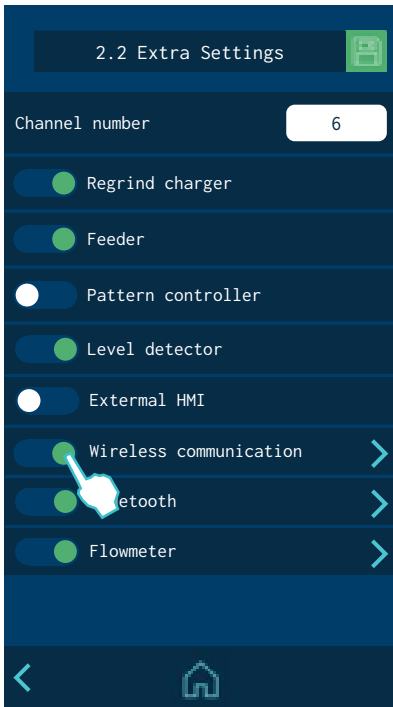

Wireless communication (Wi-Fi)

Optionally, the unit comes equipped with a wireless communication system to connect to a local network. This system connects the unit to a Meler Services Platform[*] with the following main functions:

- **Monitoring.** Regularly sends the platform’s status and operating data. The data can be configured according to user needs.
- **Actions and Programming.** It is possible to send specific actions or change the programming of a specific unit.
- **Technical support.** The unit provides direct information on its status and can schedule unit maintenance or keep a log of all interventions done on it.

[*] Check with the After-Sales Service or your Meler Sales Agent for more information about this service performance.

Connection configuration

1. Install the ‘Espressif Esptouch’ app on a smartphone device.
2. Connect the device to the local Wi-Fi network where you want to connect the melter, then run the app.
3. On the melter’s screen, click START to start syncing. Follow the instructions on the app to configure the melter’s Wi-Fi access.
4. The unit’s screen will show the connection status, the name of the Wi-Fi network, and the IP address automatically assigned.

You can also configure the following options from this screen:

- **Remote control.** Enables the unit to be able to receive actions.
- **Remote software update.** Enables the unit to be able to receive software updates.
- **Static configuration.** Enables the configuration of a static IP address for the melter.

Flowmeter

Optionally, the unit can come equipped with an adhesive flow control system with the following functions:

- Immediate measurement of adhesive consumption by time and by product (<5% error).
- Configuration of 5 products with editable names.
- Programmable alarm for consumption that exceeds programmed limits.
- Target consumption by product.
- Automatic learning of target consumption by product.
- Automatic adjustment based on the pattern being used and the working speed.
- Automatic adjustment of the system when the working pressure changes.
- Automatic or manual system calibration.
- Automatic calculation of the adhesive density.
- Flow adjustment by manually entering a value into the correction field.
- Selector of programmed products from the start screen.
- Total statistics and statistics for each product.

System calibration

This function can be activated or disabled via the '2. Additional set-up / 2.2 Additional settings' screen. To calibrate the system, press the right arrow in the Flowmeter option.

Calibration must be done when:

- The unit is programmed for its first use.
- The type of adhesive is changed.
- The working temperature is changed.
- Accuracy losses are noticed.
- Regularly (3-4 weeks), for jobs with low adhesive consumption.

Important: During calibration, the unit must be at the working pressure and temperature.

1. Enter the unit's hydraulic pressure.
2. Press 'Play' in 'Calibration' and the unit will automatically do the calculations. Depending on the programmed pressure and temperature and the adhesive type, the time could be up to a maximum of 1 hour.
3. When the calculation is completed, it will show 'Ready' next to the 'Play' button. The 'Adjustment' section will show the calculated value. The value will be between 30 and 1000, depending on the viscosity of the adhesive, the temperature, and the working pressure.
4. Press 'Save' once the process is completed.

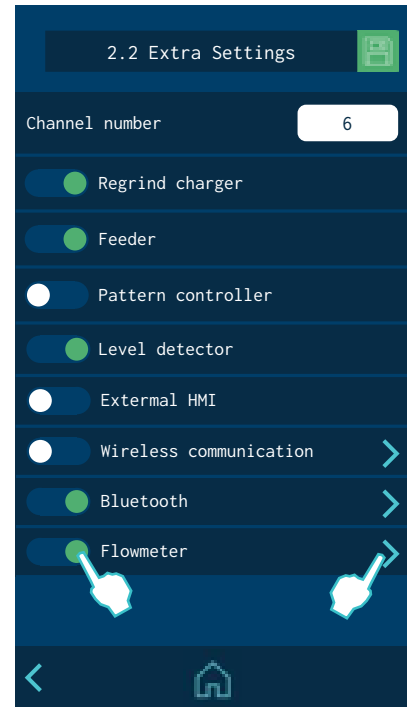

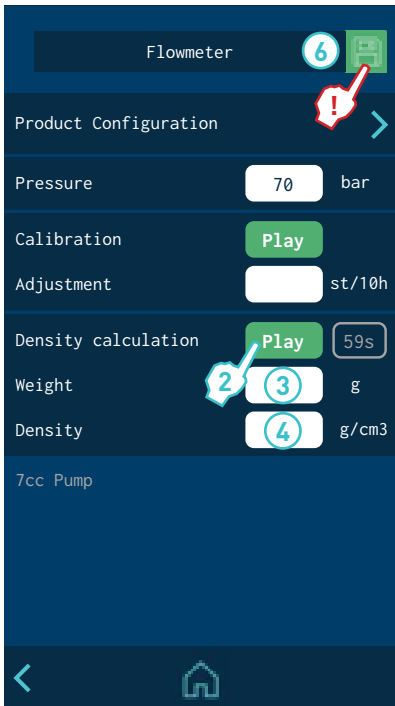

Calculating the adhesive density

The calculation must be done when:

- The unit is programmed for its first use.
- The type of adhesive is changed.

Important: During the calculation, the unit must be at the same pressure and temperate at which the system calibration was done.



Warning: Always wear gloves and safety goggles. Burn risk.

1. Prepare a container and a scale (tared with the weight of the container). The unit must be ready to fire freely through an applicator.
2. Press 'Play' in 'Automatic density calculation'. A 10 second countdown begins to get ready for application. Once this time has passed, an alarm sounds and adhesive will be applied freely into the container for 60 seconds.
3. Another alarm will sound after 60 seconds. Stop the adhesive application, weigh it, and enter the value in the 'Weight' section.
4. The unit automatically calculates the density and updates the value in the 'Density' section.
5. Optionally, you can directly enter the adhesive density value at the working temperature manually (value between 0.8 and 1 gr/cm3).
6. Press 'Save' once the process is completed.

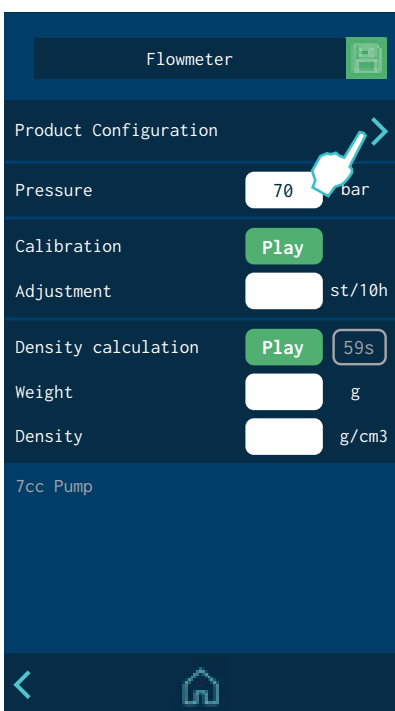

Product configuration

Once the calibration is done you can now work accurately with the flowmeter. Before and during the job you can change a set of parameters that are configured from the flowmeter settings menu.

You can configure up to 5 different products. To edit them, press 'Product configuration'.

A list appears with 5 products that are named 'Product 1', 'Product 2'... 'Product 5' by default.

The product you are working with appears in blue and the product selected to edit appears in yellow.

Press 'Edit' to change the values of the selected product.

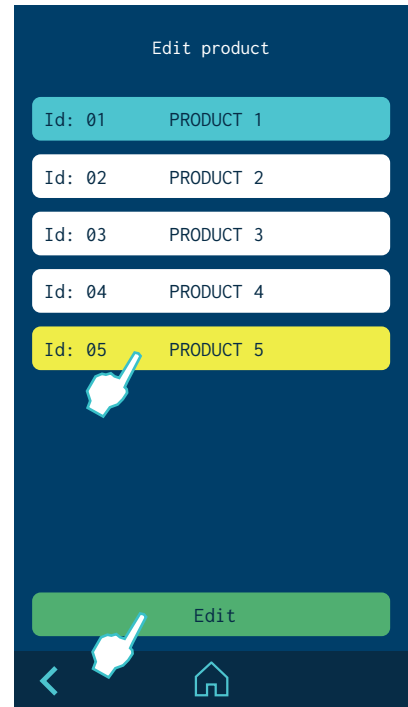

- **Name:** Click the white box to edit the name of the product.
- **Target consumption:** This shows the target consumption in grams by product. It can be programmed manually or via automatic learning.

Automatic learning: The target consumption value can be calculated automatically for each product while it is happening.

To do so, press the 'Play' button when you can see that the product has the correct amount of adhesive. The unit will then count 10 products, take the average consumption per product, and indicate it in the target consumption text box. Press the save icon to save this number.

- **Alarm:** This is the percentage of the target consumption from which the consumption is considered to be incorrect. The value entered applies to for both the upper and lower limits.

If a product is outside the consumption limit, a warning appears on the unit. The warning remains until a product passes that is within the programmed adhesive consumption limits.

Another warning is shown after 5 minutes if the product consumption remains outside the limits. The warning is saved in the notifications log and can be queried from the 'Alarms' menu.

- **Correction:** You can program a correction percentage (positive or negative) to be applied to the 'target consumption' for each product.

For instance, if the system calculates 100 g/pr for a particular product and the actual value is 101 g/pr, you can enter '1%' to more accurately adjust the consumption calculation.

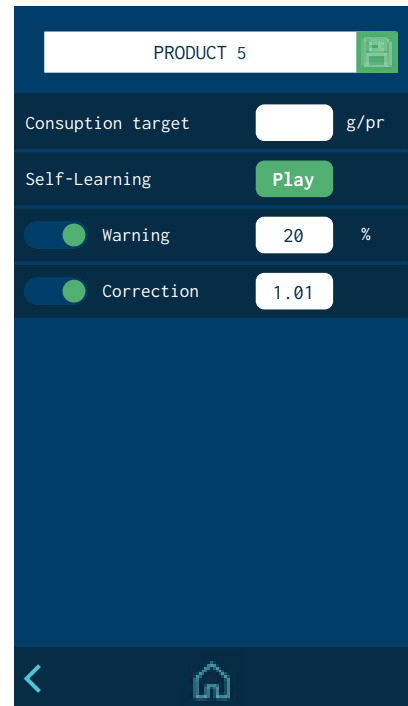

Product selection

Press the piston icon on the 'Home' screen to select the product you want to work with.

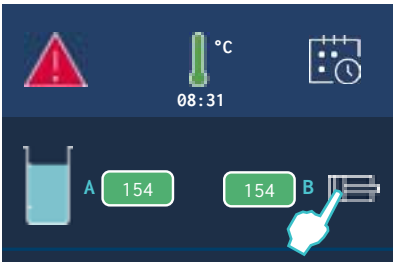

The screen shows the adhesive consumption data in real time by product, as well as the target consumption programmed for the selected product.

During operation you can change the working pressure without having to recalibrate, thanks to the system's automatic adjustment function.

To change the product you want to work with, click the white box with the product name.

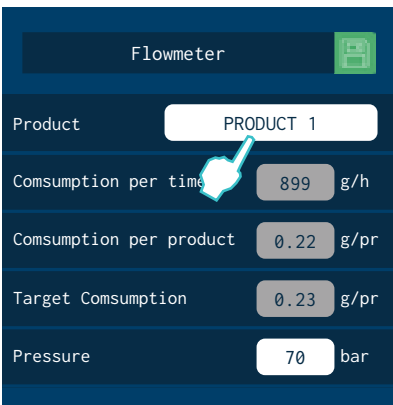

The screen will show the 5 selectable products. The product you are working with is shown in blue and the product you are now selecting to work with is shown in yellow.

When you select one of the products, its configuration is loaded into the flowmeter with the data previously programmed.

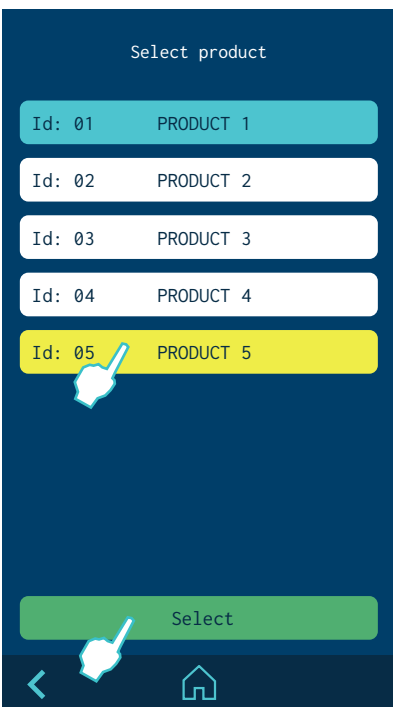

Flowmeter statistics

To access the flowmeter statistics menu, go into menu '3. Statistics' and press the right arrow in 'Flowmeter'.

The statistics screen is divided into 6 sections. The first section is for TOTAL PRODUCTS. It is the counter for the accumulated total adhesive consumption, the total products counted and the total average consumption. The other five sections are for the 5 configurable products.

The statistics are automatically saved every 30 minutes, every time a product is reset, every time you select a product, and every time you press 'Save'. When there are unsaved data, the 'Save' option appears in green and you can save by pressing it, so as not to lose any data before switching off the unit.

Each individual product and the total products section can be reset separately.

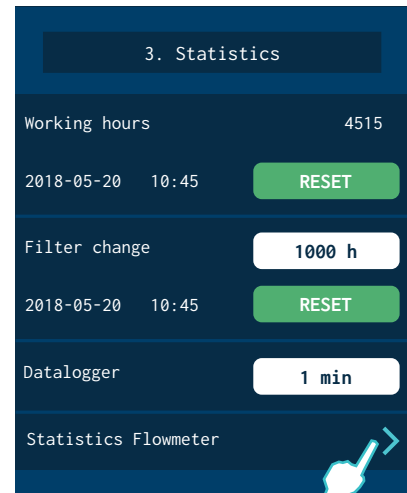

Standby function

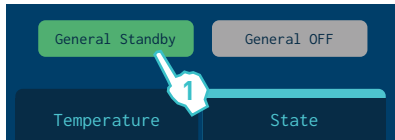

Area	Standby	OFF
T: Tank	<input type="checkbox"/>	<input checked="" type="checkbox"/>
D: Distributor	<input checked="" type="checkbox"/>	<input type="checkbox"/>
1.1: Hose 1	<input type="checkbox"/>	<input checked="" type="checkbox"/>

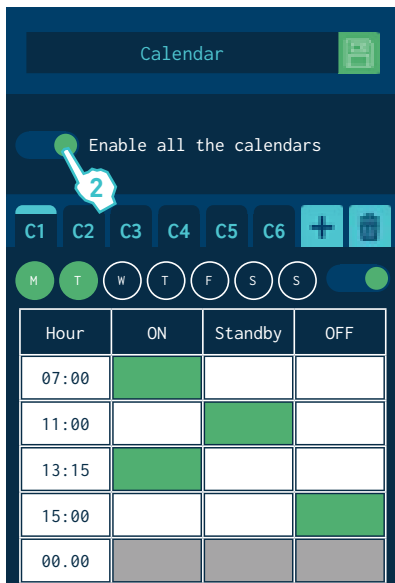
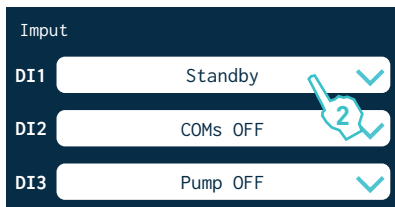

Using the standby function during periods of melter/appliator inactivity helps save energy and allows the heated elements to return quickly to their set point temperatures once you return to the operational mode.

When the function is activated, the target temperature of the heated zones is reduced to the programmed value for each zone (see 'Heating menu / Heating zones').

For example, if the target temperature of the tank is 160°C and the Under Maintenance parameter is set to -30°C, when the Under Maintenance function key is pressed, the tank's set point temperature will change to 130°C.

The priority protocol is as follows:

- 1st Under Maintenance external signal.
- 2nd 'Under Maintenance' function key.
or calendar programming.
- 3th individual Under Maintenance function key.

Therefore, while the Under Maintenance external signal remains active, none of the other three systems can deactivate the function.

The following criteria are suggested for standby function use:

- If the period of inactivity is less than 2 hours, allow the melter applicator equipment to heat as normal.
- If the period of inactivity is more than 2 hours and less than 4 hours, use the standby function.
- If the period of inactivity is over 4 hours, use one of the following two options: turn off the equipment if you do not plan on using it for the rest of the day or keep the standby function on if you plan on using the equipment during that same day.

Turning off the melter equipment

If you need to disconnect the melter equipment:

1. Turn off the machine switch.



The depressurization valve frees pressure from the hydraulic circuit, returning the adhesive to the tank.

2. Disconnect the pneumatic power to the applicators and the electrical power to the control unit programmer, if there is one.



Use of the automatic feeder

This section presents how to use the automatic feeder. Even if its operation is very simple, it should not be used by non-trained personnel.

Start up and automatic process

The operation of the vacuum feeder is absolutely automatic and only needs to switch it on in the program menu, to begin the automatic feeding when the low level sensor requests it.

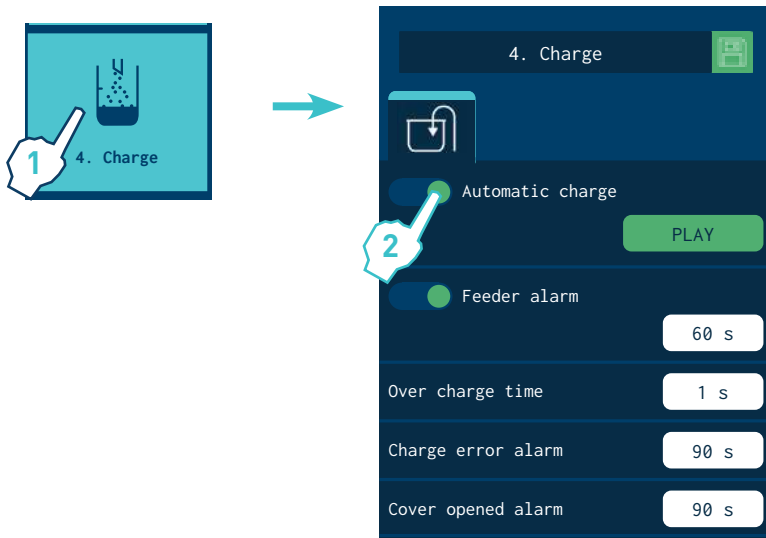

The automatic loading process is developed according to the following pattern:

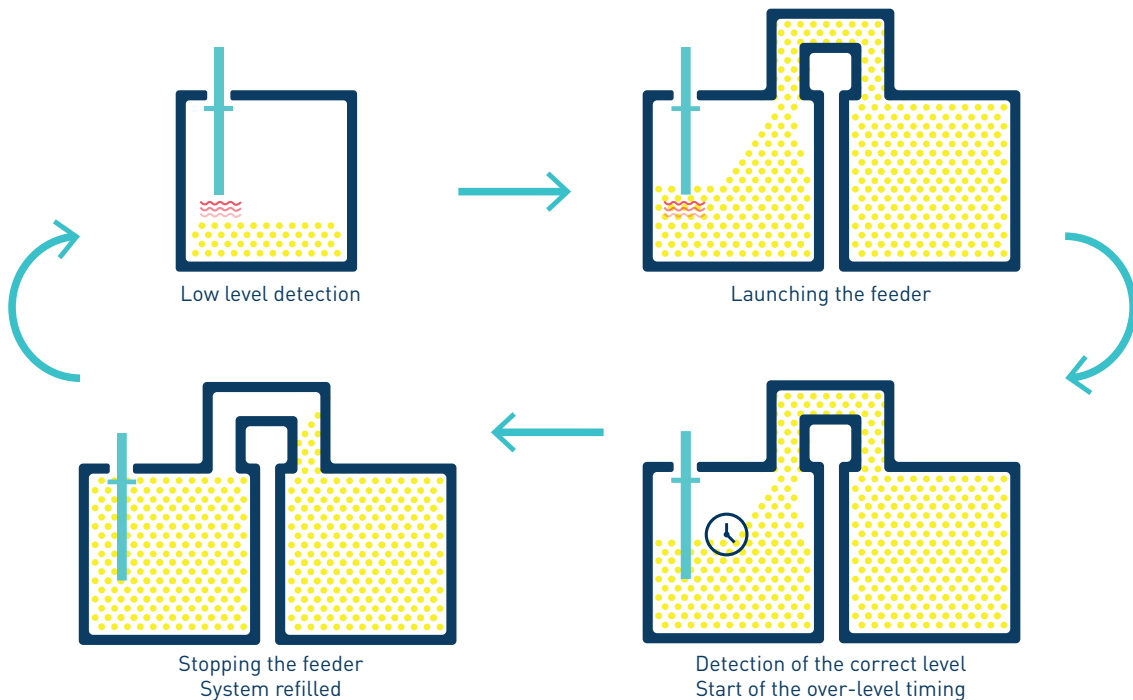



Sensitivity adjustment

The adjustable sensitivity of the sensor is factory pre-set and therefore it is NOT necessary to change. In most cases the factory setting is perfectly valid to use the automatic feeder.

Positioning of the level sensor

The sensor is supplied factory set so that, when the pellet level is around 10 mm below the sensor, it detects a full tank (green LED).

Depending on the type of pellet used, it may be necessary to make a final adjustment when starting up the system:

Important: Use the working adhesive at the operating temperature.

Warning: Hot zone with high temperatures. Risk of burns. Use thermal protective equipment.



1. With the unit at the operating temperature and the sensor clean, fill the tank with the pellets that you are going to work with, up to what is considered the 'tank full' level.
2. Move the capacitive sensor up/down in relation to the tank lid, right until the colour of the LED changes from green to red. The LED should remain red.

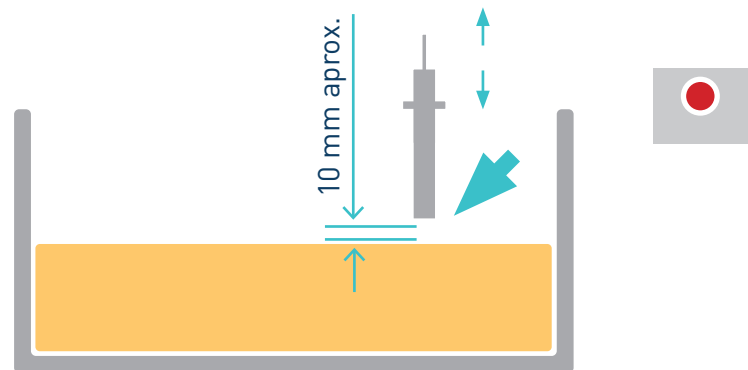

3. We recommend checking that it is properly set by running a few automatic reloading cycles.



Note: If the sensor sensitivity setting needs to be corrected, contact Meler's after sales service or the area representative.

Application for PC

An optional application for PC^(*) allows you to connect the unit with a USB port and perform the following functions:

- Update the HMI board software.
- Update the IOC board software.
- Update the TC board software.
- Make a complete backup of the system.
- Restore a complete backup of the system.
- Flash memory deletion.
- Make a backup of the Datalogger.

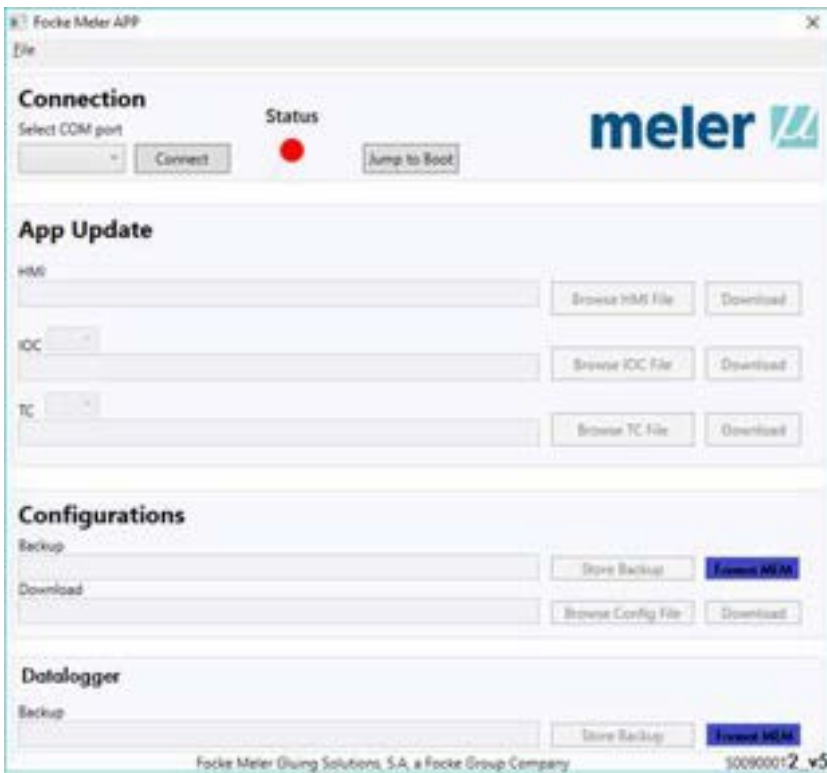

(*) <http://www.meler.eu>

Warning: For more information consult your Focke Meler Representative or the Focke Meler Main Office.



This page is intentionally left blank.

5. MAINTENANCE

Warning: The melter equipment is equipped with current technology, but has certain foreseeable risks. Therefore, only allow qualified personnel with enough training and experience to operate install or repair this equipment.



The following table briefly summarizes the indications for adequate melter equipment maintenance. Always read the corresponding section carefully.

Operation	Frequency	Refer to
External cleaning	Daily	Equipment cleaning
System depressurization	Before performing maintenance tasks and repairing the hydraulic system	System depressurisation
Remove electrical cabinet	Before performing pneumatic unit or pump shaft maintenance	Access to pneumatic unit
Filter cleaning or changing	- As needed (once a year minimum) - With each adhesive change	Filter maintenance
Emptying and cleaning the tank	- When burnt adhesive is present - With each adhesive change	Cleaning the tank
Check thermostat operating	- Check in continuous work	Safety thermostat
Equipment change	- Equipment change or repair	Remove the equipment from its base

Equipment cleaning

To continue to take advantage of the melter’s benefits and to ensure the perfect mobility of its components, it is necessary to keep all its parts clean, especially the ventilation grate on the upper part of the machine.

Warning: Risk of electric shock. Carelessness may result in injury or death.



Clean the exterior using a cloth moistened with water. Do not use flammable liquids or solvents.

To carry out external cleaning:

- Use cleaning products compatible with polyamide materials.
- Apply the cleaning product with a soft cloth.
- Do not use sharp tools or scrapers with sharp edges.



Removing and changing exterior panels:

1. Turn off the melter.
2. Disconnect the compressed air from the machine intake.
3. To remove the casing from the machine, first you have to separate the electrical cabinet from the tank. To do this, slacken the 1/4 turn screw as indicated (A) and slide it along the guides.
4. To remove the electrical cabinet door, open the door by turning the 1/4 turn screw as indicated (B), lift the door, turn it and remove the screws (C).
5. To remove the electrical cabinet casing, slacken the screws (D) that hold it to the base of the machine and the screws (E) that hold it to the structure of the electrical cabinet.
6. To remove the tank casing, remove screws F and G that hold this casing to the base of the equipment. The lid and the casing are removed from the tank at the same time.
7. The tank lid of MICRON+ 5 and 10 is removed once the tank casing has been dismantled. It is simply a matter of sliding the shafts at the ends along the grooves in the casing. (See diagram 1).

The tank lid of MICRON+ 20 and 35 is removed loosening the side lid screws (See diagram 2).

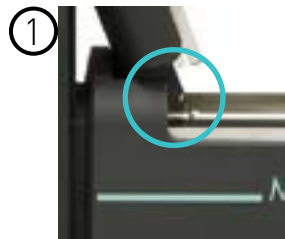

8. To assemble the casing, follow the instructions in reverse order.

System depressurisation

'MICRON+' series melters are equipped with a safety valve that allows you to depressurize the system whenever the equipment is pneumatically or electrically disconnected.

Before disconnecting any hydraulic component or opening any distributor output, it is necessary to follow these steps:

1. Turn off the machine switch on the door of the electrical cabinet next to the pressure regulator.
The depressurization valve releases the pressure from the hydraulic circuit, returning the adhesive to the tank.
2. Purge all applicators that have been used either manually or with the corresponding program command.

Access to pneumatic unit

To access the unit for more exhaustive machine maintenance, it will be necessary to remove the electrical cabinet from its place so it can be handled more comfortably and accessibly. To do this, slacken the 1/4 turn screw that keeps the electrical cabinet in position (screw A) and slide it along the guides.

To carry out this operation it is not necessary to open the electrical cabinet door.

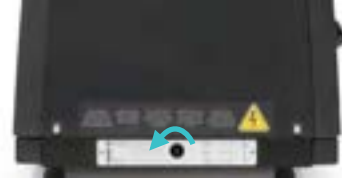

Maintenance of the filters

'Micron+' series melter equipment is equipped with a 50 mesh pump filter. The filter prevents impurities and burnt adhesive remains from being pushed out from the tank by the pump.

The adhesive flows from the inside to the outside of the filter, with impurities being trapped inside it.

The drain valve is included in the filter cap.

There is also a filter in the tank's inlet valve. This filter performs a first-step filtration, preventing impurities resulting from burning in the tank and other impurities that may enter from the outside from passing through.

The filters can be cleaned or replaced with new ones.

No rule exists for determining when to change the filters. Several factors influence this decision:

- the type and purity of the adhesives used.
- the adhesive work temperatures.
- adhesive consumption in relation to the time it spends in the tank.
- changes in the type of adhesive used.

In any case, we recommend that the filters are checked and cleaned at least every 1000 hours of operation (melter turned on).

Warning: Always use protective gloves and goggles. Risk of burns.



Changing the pump filter

To change the filter, it should be borne in mind that the filter and purge valve are the same assembly:

1. Depressurise the system.
2. To remove the whole filter, unscrew the assembly's hexagonal plug using a 27 mm socket driver and remove it.
3. Depending on the amount of dirt inside the cartridge, clean it or throw it away, following the applicable waste regulations.

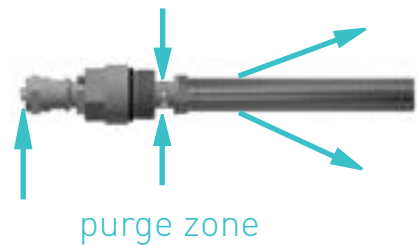

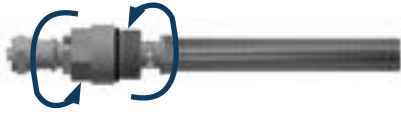

4. Replace the joints if they are damaged.
5. Unscrew the old cartridge in the clockwise direction. Screw the assembly up again, counterclockwise.
6. Put the assembly back inside the distributor and tighten the screws.
7. Continue to work as normal.

Changing the inlet filter



Warning: It is important to install and remove the filter as instructed below, to prevent the inlet valve from coming loose.

Bear in mind that the inlet filter is screwed onto the inlet valve via a right-handed thread and that this, in turn, is screwed onto the distributor's adapter via a left-handed thread.

1. Empty the tank.
2. Remove the grid from the bottom of the tank, taking care not to scratch it.
3. Put the unit on Standby.
4. Remove the filter unit with a size 17 socket driver, turning the unit's head anticlockwise.
5. Depending on how dirty the filter is, replace the mesh or the entire unit, disposing of it in accordance with the current waste regulations.
6. Reinstall the filter unit, screwing it clockwise onto the inlet valve.



Important: It should only be tightened by hand and should not be forced, to avoid loosening the inlet valve.

7. Fill the tank with adhesive and continue working as normal.

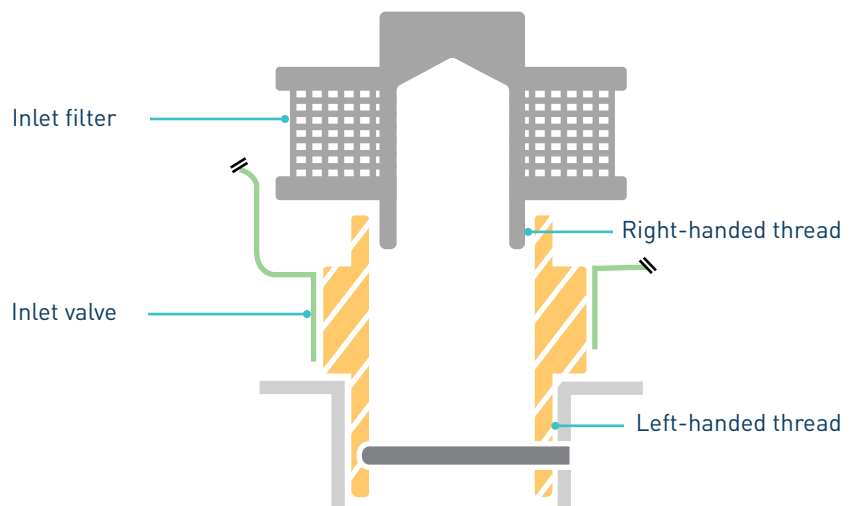

Cleaning the tank

The hot-melt tank must be cleaned on occasion to maintain its fusion and anti-adherence properties. The tank is covered on the inside with PTFE and inclined enough to aid unloading the hot-melt and to avoid it from being retained inside when consequential burning occurs.

Furthermore, when adhesives are mixed, reactions may occur between them, causing a degeneration and thus problems in unloading in the direction of the pump.

Therefore, it is recommended to clean the deposit every time that:

- a change is made to a different type of hot-melt.
- too much burnt material is generated in its interior.



Changing adhesive type.

1. Use up as much of the adhesive as possible.

If it is necessary to unload the adhesive without having used it up as much as possible, follow the instructions in the section 'Emptying the tank'.

2. Clean the remains of hot-melt adhesive on the inside of the tank.

Warning: Use appropriate protective equipment for high temperatures.

3. Add the appropriate type and quantity of the new adhesive, wait for it to melt and pump at least one full tank through the system (hoses and applicators).



Cleaning burnt adhesive

1. Empty the tank directly (see the section 'Emptying the tank') to prevent the burnt material from passing through the pump circuit.
2. Clean the adhesive remains and burnt material inside the tank. Do not use sharp objects that might damage the inside coating.

Warning: Use appropriate protective equipment for high temperatures.

3. Add the appropriate type and quantity of adhesive and wait for it to melt.
4. Remove the filter cartridge and clean it, if necessary (see the section 'Filter maintenance').
5. Reassemble the filter without the cartridge.





6. Pump until the adhesive comes out clean again through the distributor output marked number 1.
7. Remove the filter and attach it to the corresponding cartridge. Reinstall it in the distributor.
8. Refill the tank with adhesive, wait for it to melt and continue working as usual.



Warning: Whenever you handle the filter or any other element subject to pressure, you must always perform a system depressurization first (see the corresponding section)

Emptying the tank



During normal maintenance activities, it is recommended, and sometimes necessary to empty the tank directly, without passing the adhesive through the pump system.

In the case of the MICRON+ 5, the tank does not have a pouring chute so, to empty out the adhesive you need to wait until it has cooled and separate it from the walls of the tank, making it easier to remove.

For the other models, empty the tank following these indications:

1. Keep the tank at working temperature.
2. Remove the tank cover and then its casing.
3. Lower the emptying chute attached to the tank and put a suitable container in position.
4. Unscrew the plug and allow the adhesive to flow freely into the container.
5. Once it is completely empty, clean the exit hole and chute of remains of adhesive.
6. Put the plug back in position.
7. Raise the emptying chute and put the cover of the casing back in position.



Warning: Use appropriate protective equipment for high temperatures.

Safety Thermostat

If there is an error in the resettable thermostat. Dismantle the tank casing with the cover and slide the electrical cabinet along. When you can see the thermostat, press the button indicated to reset it.



Warning: Use appropriate protective equipment for high temperatures.



Remove the equipment from its base

For more thorough equipment maintenance, it is necessary to remove it from its present location to be able to perform operations more comfortably and with greater accessibility.

To do this, the equipment should be removed from its base following these indications:

1. Turn off the machine switch on the door of the electrical cabinet next to the pressure regulator.
2. Depressurise the system.
3. Disconnect the hoses connected to the distributor outputs both electrically and hydraulically.
4. Disconnect the input power supply and ground connection.
5. Raise the machine to extract it from the base.



Automatic feeder maintenance



Warning: The vacuum feeder is a device with updated technologies but with certain risks. Therefore, you should allow only the right people, with sufficiently enough training and experience, handling, installation or repair of these devices.

The following table summarizes briefly the indications for proper maintenance of the vacuum feeder. Read carefully, in each case, the corresponding section.

If the device does not work or works incorrectly contact the Technical Services 'meler' or Area Representative.

Operation	Frecuency	Refer to
External cleaning	Daily	Cleaning of the unit
Pneumatic system	- Daily: pressure control - Weekly: leakage inspection	Pneumatic circuit
Load sensor	- Daily: load control - Weekly: cleaning	Control of load sensor
Suction tube	Weekly	Inspection aspiration tube
Air exhaust filter	Weekly	Filter maintenance
Pneumatic vibrator	Weekly	Control of pneumatic vibrator



Cleaning of the unit

To maintain the performance of the vacuum feeder in perfect functioning, all of its components must be maintained clean and especially the exits in the air suction tube.

Eliminate waste that can clog the air outlets.

Keep clean and without obstructions the tube for the adhesive.

Clean items with a soft tissue and aspire the dust that can be accumulated.

Pneumatic system

Control regularly the pressure feeding circuit. Very low pressures do not allow proper loading of the adhesive. Very high pressures can produce splash of molten adhesive in the tank of the melting unit and even cooling of the hot melt.

Monitor periodically if there is any leak in the pneumatic circuit. In addition to being a useless expense resulting in loss of pressure and thus malfunction of the feeding system.

Control of the load sensor

It is necessary to control if the load sensor is working properly and that it allows you to maintain the desired levels.

A low load will cause a decline in the level and the possibility of not having the amount of necessary hot-melt adhesive. By contrast, an overload can cause the overfilling of the tank with subsequent sealing of the loading mouth.

The load sensor should remain clean of charred adhesive that may affect the proper level detection.



Inspection of the aspiration tube

Monitor that the aspiration tube is not obtured with sticked glue pallets or perls. This tube should be perfectly free of any glue plugs that impedes the smooth transfer of the adhesive from container to the tank of the melting unit.

The tube is mostly transparent to facilitate visual inspection of the same.



Filter maintenance

Periodically review the state of the filter located inside the discharge zone. Blow compressed air impurities that may have acceded to.

This filter avoids dust particles or glue pallets itself being spilled outside with the exhaust air. If it arrived to be plugged the system might not work properly.

To clean, unscrew the three screws of the rotary elbow lid and extract the filter.



Control of pneumatic vibrator

Reviewing the correct operation of the pneumatic vibrator located in the suction mouth. Ensures that it vibrates and its vibration is adequate.

Clean up the exhaust silencer of impurities and adhesive dust.



This page is intentionally left blank.

6. TECHNICAL CHARACTERISTICS

Generals

MICRON+5

MICRON+10

Tank capacity	5.15 liters	9.7 liters
Pumping rate	29.3 kg/h 7cc/stroke pump (*) 66.0 kg/h 19cc/stroke pump (*)	29.3 kg/h 7cc/stroke pump (*) 66.0 kg/h 19cc/stroke pump (*)
Melting rate	9.0 kg/h (*)	13.5 kg/h (*)
Number of hydraulic outputs	6 (thread 9/16)	6 (thread 9/16)
Number of electrical outputs	2, 4 or 6	2, 4 or 6
Temperature range (optional)	40 to 200 °C (104 to 392 °F) 40 to 230 °C (104 to 446 °F)	40 to 200 °C (104 to 392 °F) 40 to 230 °C (104 to 446 °F)
Temperature control	RTD ±0.5 °C (±1 °F) Pt-100, Ni-120 or NTC-R	RTD ±0.5 °C (±1 °F) Pt-100, Ni-120 or NTC-R
Max. working pressure (at 6 bar)	81.6 bar (1183 psi)	81.6 bar (1183 psi)
Max. installation power (Maximum current allowed is 27A per phase)	5900 W (2 electrical outputs) 9500 W (4 electrical outputs) 13100 W (6 electrical outputs)	6900 W (2 electrical outputs) 10500 W (4 electrical outputs) 14100 W (6 electrical outputs)
External functions		
Inputs	Unit On-Off • Standby On-Off • Activity Control • Pumping On-Off • Communications On-Off • Electrical Outputs Inhibition • Reset Alarms	Unit On-Off • Standby On-Off • Activity Control • Pumping On-Off • Communications On-Off • Electrical Outputs Inhibition • Reset Alarms
Outputs	Standby • Zones Temperature OK • Machine Ready • Running • Alarm • Level • No Level	Standby • Zones Temperature OK • Machine Ready • Running • Alarm • Level • No Level
Electrical requirements	1N ~ 230V 50/60Hz + PE 3N ~ 400V 50/60Hz + PE (optional) 3 ~ 230V 50/60Hz + PE (optional) 3 ~ 400V 50Hz + PE with transformer base	1N ~ 230V 50/60Hz + PE 3N ~ 400V 50/60Hz + PE 3 ~ 230V 50/60Hz + PE 3 ~ 400V 50Hz + PE with transformer base
Ambient temperature	0 to 40 °C	0 to 40 °C
Dimension (LxWxH)	587 x 341 x 481 mm 587 x 341 x 628 mm (lid open)	671 x 341 x 481 mm 671 x 341 x 760 mm (lid open)
Weight	37.5 kg (empty)	45.7 kg (empty)

(*) Under standard conditions

MICRON+ 20

MICRON+ 35

Tank capacity	19.7 liters	37.4 liters
Pumping rate	29.3 kg/h 7cc/stroke pump (*) 66.0 kg/h 19cc/stroke pump (*)	66.0 kg/h 19cc/stroke pump (*)
Melting rate	19 kg/h (*)	30 kg/h (*)
Number of hydraulic outputs	6 (thread 9/16)	6 (thread 9/16)
Number of electrical outputs	2, 4 or 6	2, 4 or 6
Temperature range (optional)	40 to 200 °C (104 to 392 °F) 40 to 230 °C (104 to 446 °F)	40 to 200 °C (104 to 392 °F) 40 to 230 °C (104 to 446 °F)
Temperature control	RTD ±0.5 °C (±1 °F) Pt-100, Ni-120 or NTC-R	RTD ±0.5 °C (±1 °F) Pt-100, Ni-120 or NTC-R
Max. working pressure (at 6 bar)	81.6 bar (1183 psi)	81.6 bar (1183 psi)
Max. installation power (Maximum current allowed is 27A per phase)	7400 W (2 electrical output) 11000 W (4 electrical output) 14600 W (6 electrical output)	8900 W (2 electrical output) 12500 W (4 electrical output) 16100 W (6 electrical output)
External functions		
Inputs	Unit On-Off • Standby On-Off • Activity Control • Pumping On-Off • Communications On-Off • Electrical Outputs Inhibition • Reset Alarms	Unit On-Off • Standby On-Off • Activity Control • Pumping On-Off • Communications On-Off • Electrical Outputs Inhibition • Reset Alarms
Outputs	Standby • Zones Temperature OK • Machine Ready • Running • Alarm • Level • No Level	Standby • Zones Temperature OK • Machine Ready • Running • Alarm • Level • No Level
Electrical requirements	1N ~ 230V 50/60Hz + PE 3N ~ 400V 50/60Hz + PE (optional) 3 ~ 230V 50/60Hz + PE (optional) 3 ~ 400V 50Hz + PE with transformer base	3N ~ 400V 50/60Hz + PE 3 ~ 230V 50/60Hz + PE
Ambient temperature	0 to 40 °C	0 to 40 °C
Dimension (LxWxH)	671 x 382 x 524 mm 671 x 382 x 875 mm (lid open)	738 x 435 x 673 mm 738 x 435 x 1067 mm (lid open)
Weight	60.2 kg (empty)	90.1 kg (empty)

(*) Under standard conditions

Dimensions

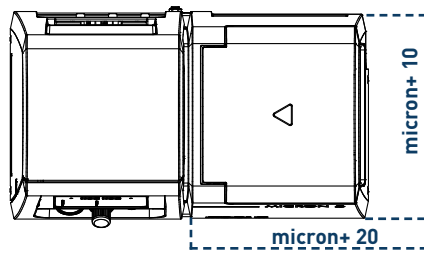
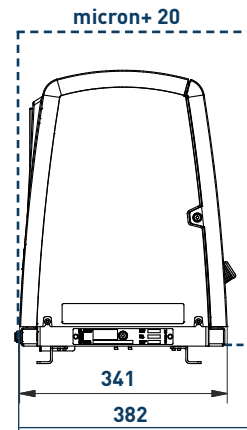
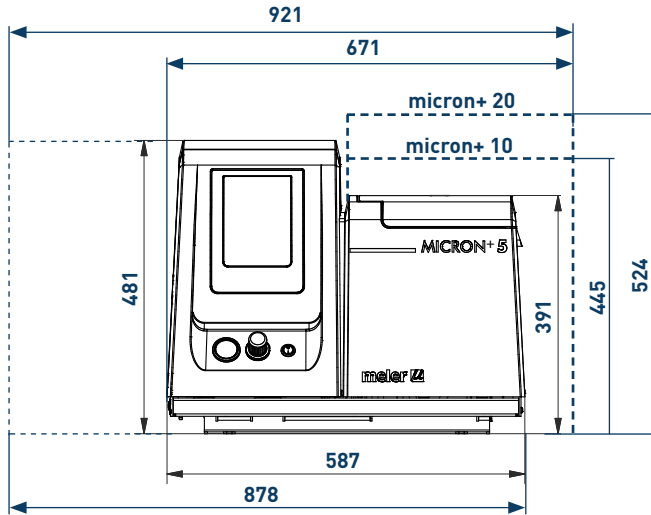

micron+ 5, 10, 20

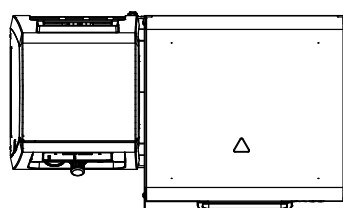
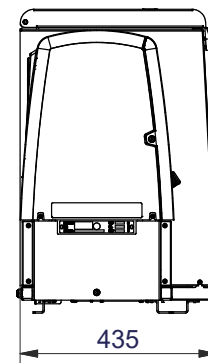
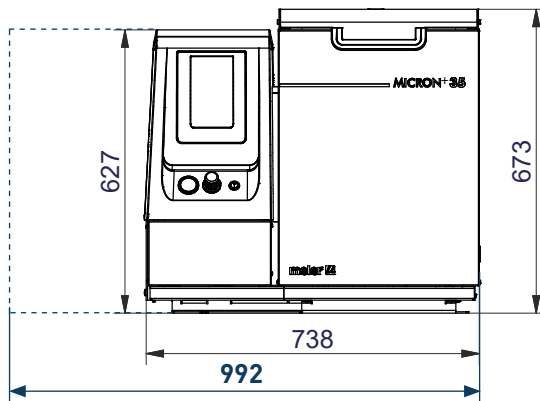

micron+ 35

UNIT FIXATION micron+ 5

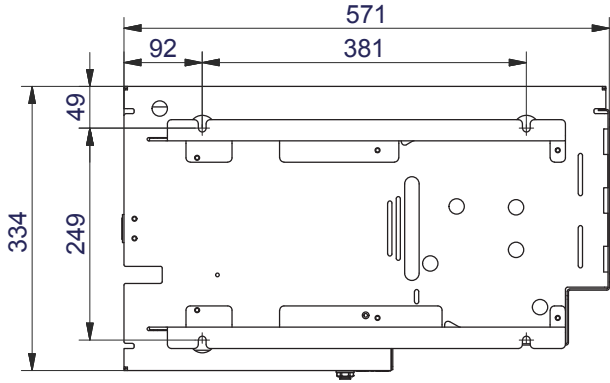

UNIT FIXATION micron+ 10

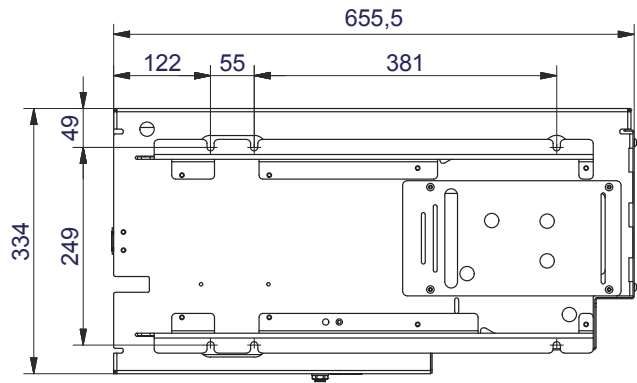

UNIT FIXATION micron+ 20

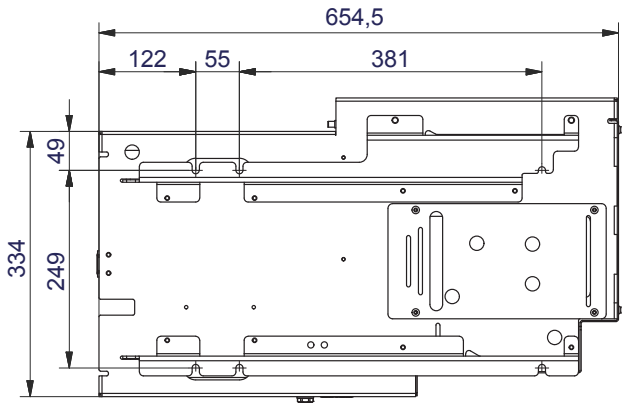

UNIT FIXATION micron+ 35

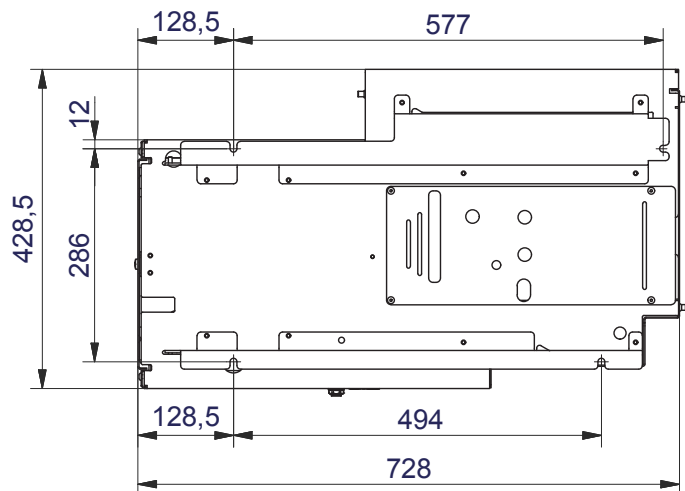

Note: the indicated holes are for M8 screws.

Accessories

Low level detection system

System for warning and/or monitoring the level of melted adhesive, with a float detector or capacitive sensor.

Caster system

For 25 and 35l Micron+ machines there is the option to add 4 casters to the base of the machine to make it easier to move.

Adaptation plate for previous models

If you want to replace a 'micron' 4, 8, or 16 range by new range 'micron+' 5, 10, or 20, you can directly change between them if the standard holes was used to fix the equipment. In this case, the equipment will be outdated a few centimeters relative to the position of the previous equipment and mooring table.

To correct this small gap there is an optional adaptation plate to attach the new units of the range in the above position. This plate is the same for all units, using the holes indicated depending on the unit (see dimensions below).

For the 'micron+' 35 units the adaptation plate does not exist.

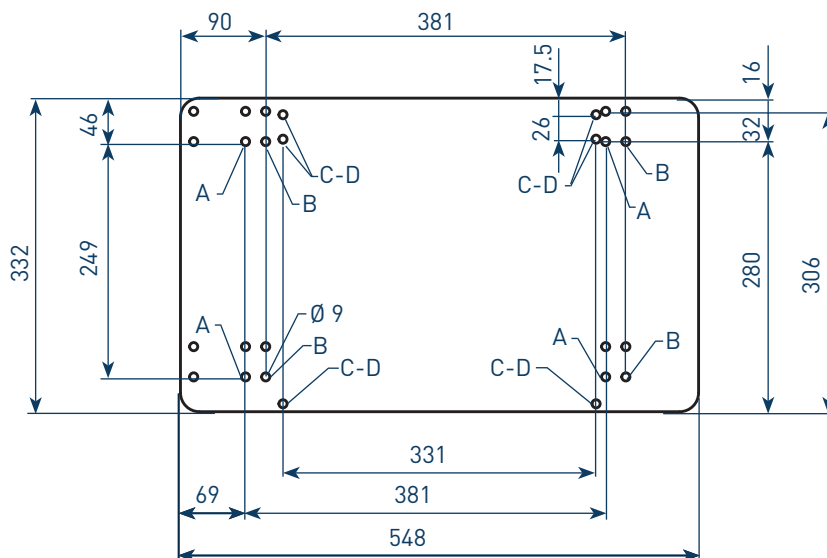

- A: micron+ 5 unit set up and replacement of other units.
- B: micron+ 10, micron+ 20 unit set up and replacement of other units.
- C: Replacement of ML-240-ST series units.
- D: Replacement of ML-260-ST series units.

This page is intentionally left blank.

7. ELECTRICAL DRAWINGS

This page is intentionally left blank.

8. PNEUMATIC DIAGRAM

Components list

7 cm³/stroke pump

- 1 Inlet filter (filtering disk)
- 2 Solenoid valve 3/2 manual override (230V 50 Hz 1.5VA)
- 3 Pressure regulator 1-8 bar
- 4 Pressure gauge 0-10 bar
- 5 Pneumatic valve 5/2
- 6 Differential valve
- 7 Pneumatic cylinder double acting double chamber
Ø50x50 (7cm³/stroke pump)
- 8 Exhaust port filter
- 9 Pressure discharge valve

19 cm³/stroke pump

- 1 Inlet filter (filtering disk)
- 2 Pneumatic valve 3/2 (80x50 cylinder)
- 3 Pressure regulator 1-8 bar
- 4 Pressure gauge 0-10 bar
- 5 Pneumatic valve 5/2
- 6 Differential valve
- 7 Pneumatic cylinder double acting double chamber
Ø80x50 (19cm³/stroke pump)
- 8 Exhaust port filter
- 9 Pressure discharge valve

With electro-pneumatic pressure regulator VP

- 10 Air filter 5µ
- 11 Pressure regulator (proportional valve)

Pneumatic connection for 7 cm³/stroke PUMP

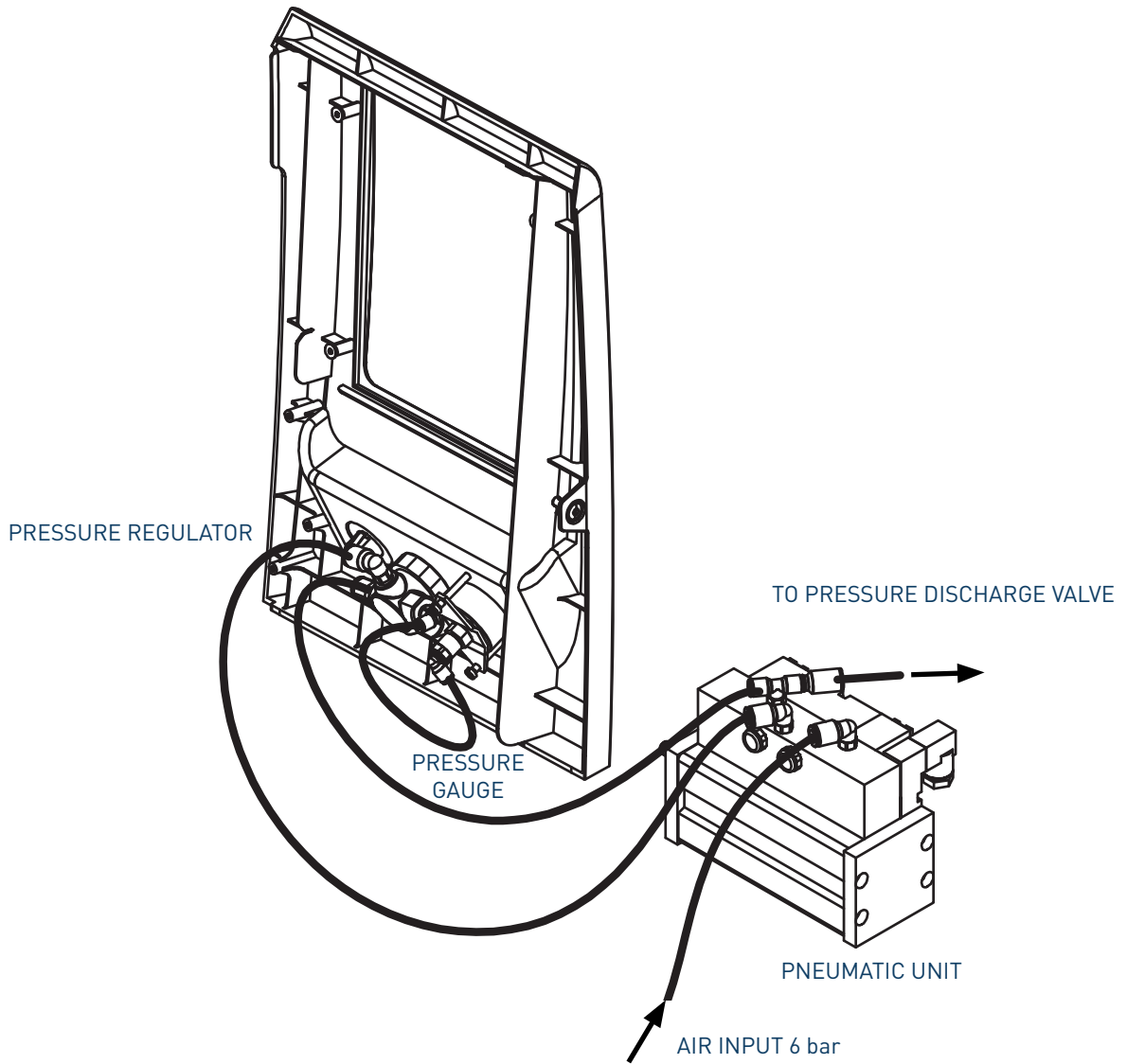

Pneumatic diagram for 7 cm³/stroke PUMP

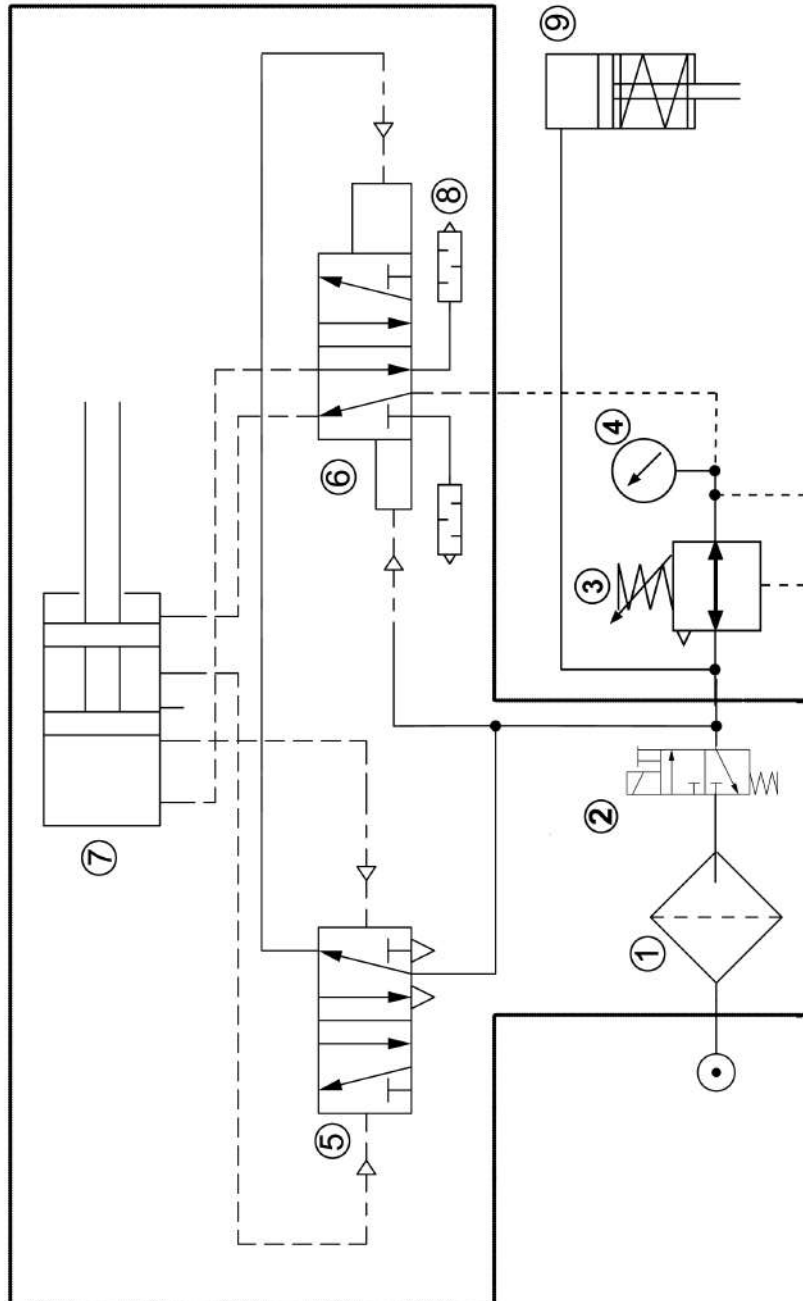

Pneumatic connection for 19 cm³/stroke PUMP

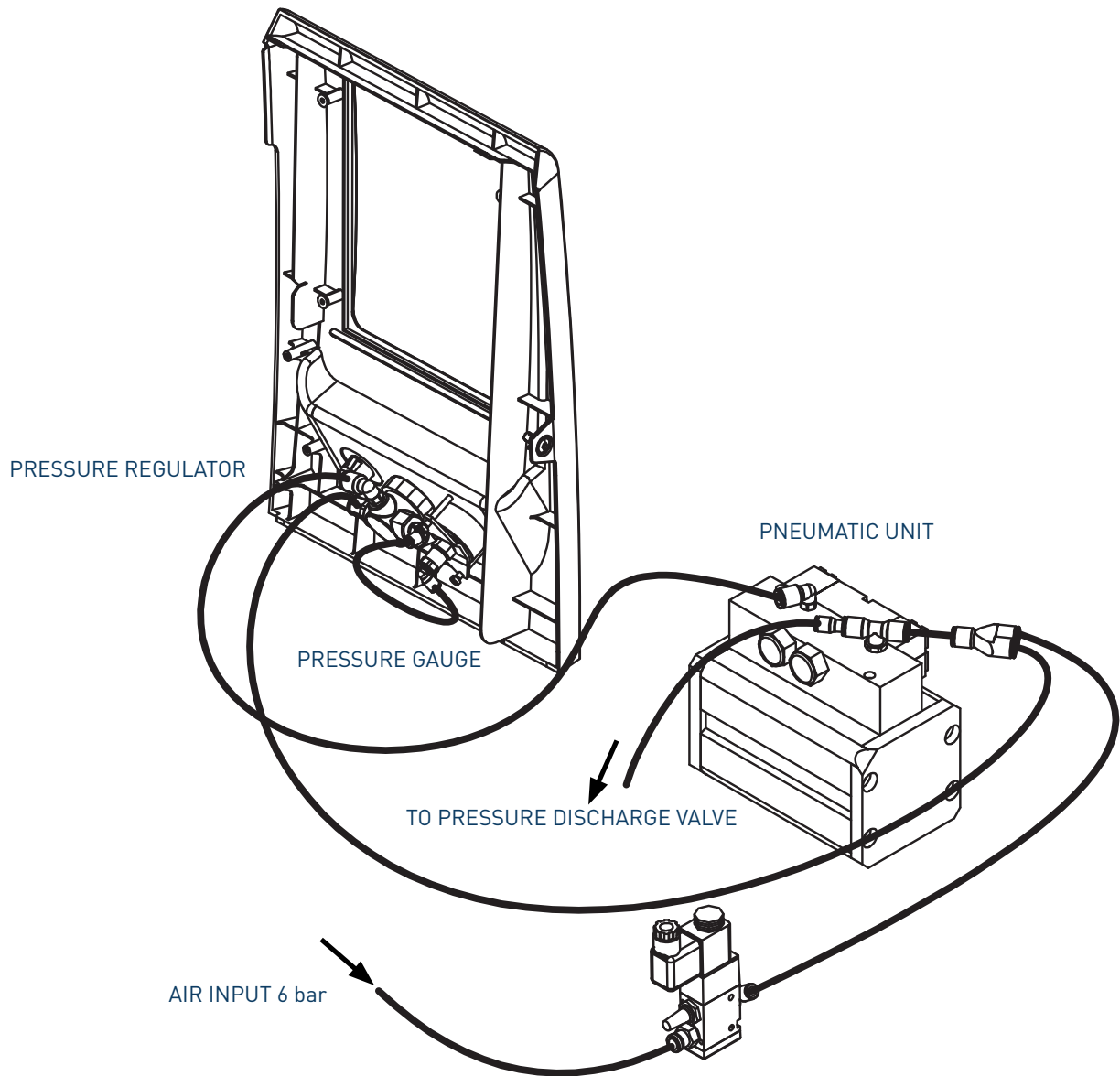

Pneumatic diagram for 19 cm³/stroke PUMP

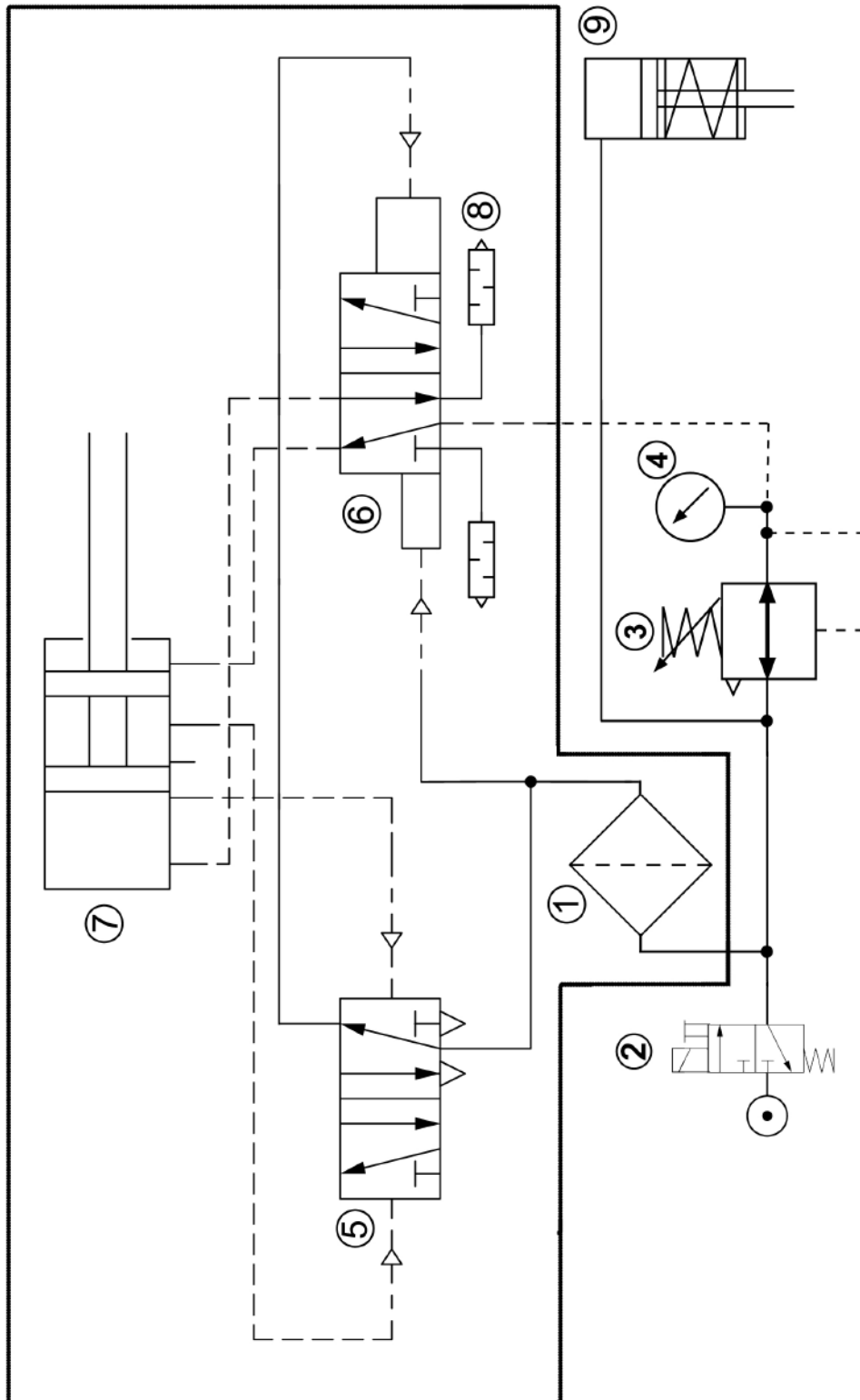

Electro-pneumatic connection with pressure regulator VP. 7 cm³/stroke PUMP

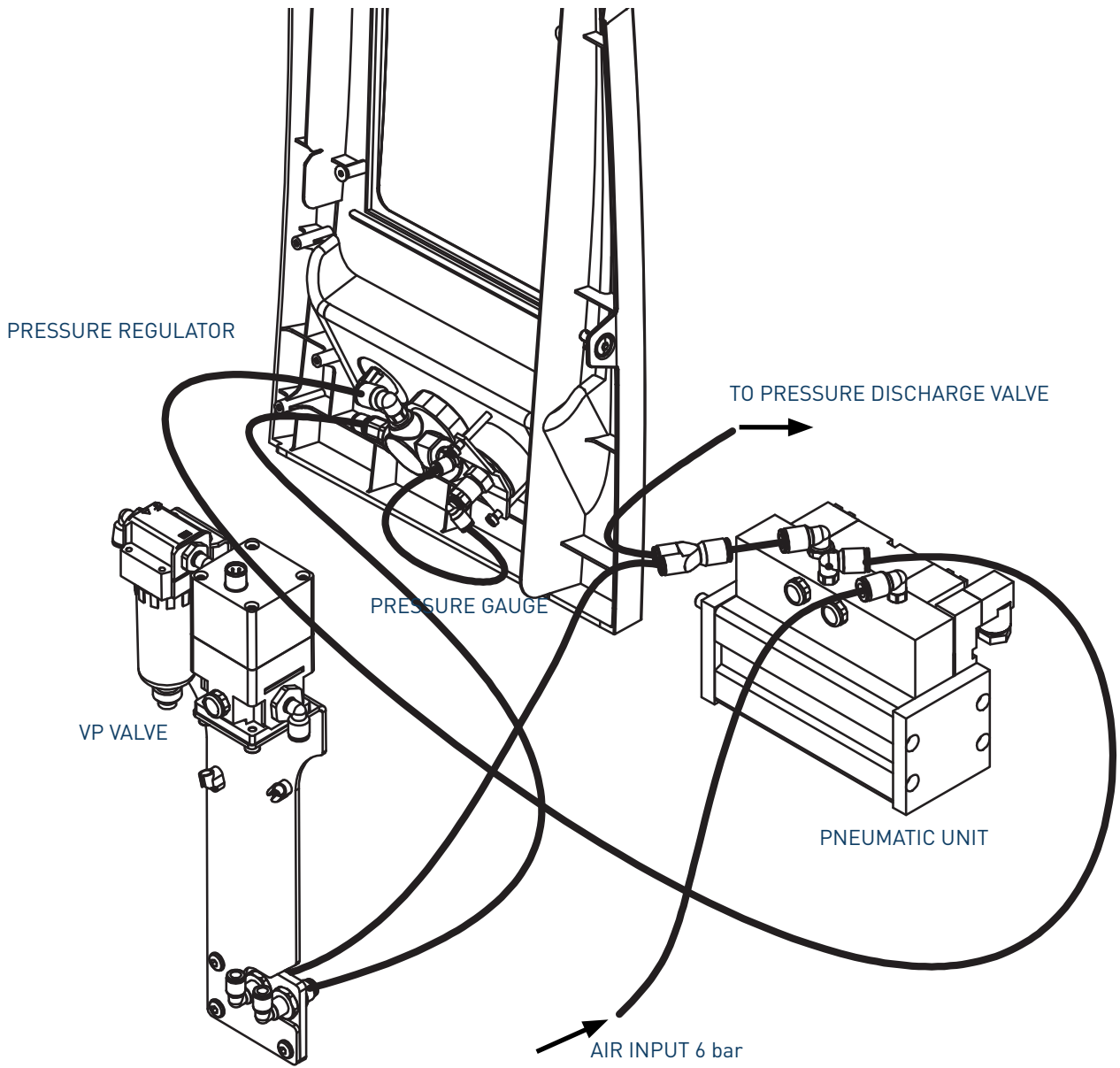

Electro-pneumatic diagram with pressure regulator VP.
7 cm³/stroke PUMP

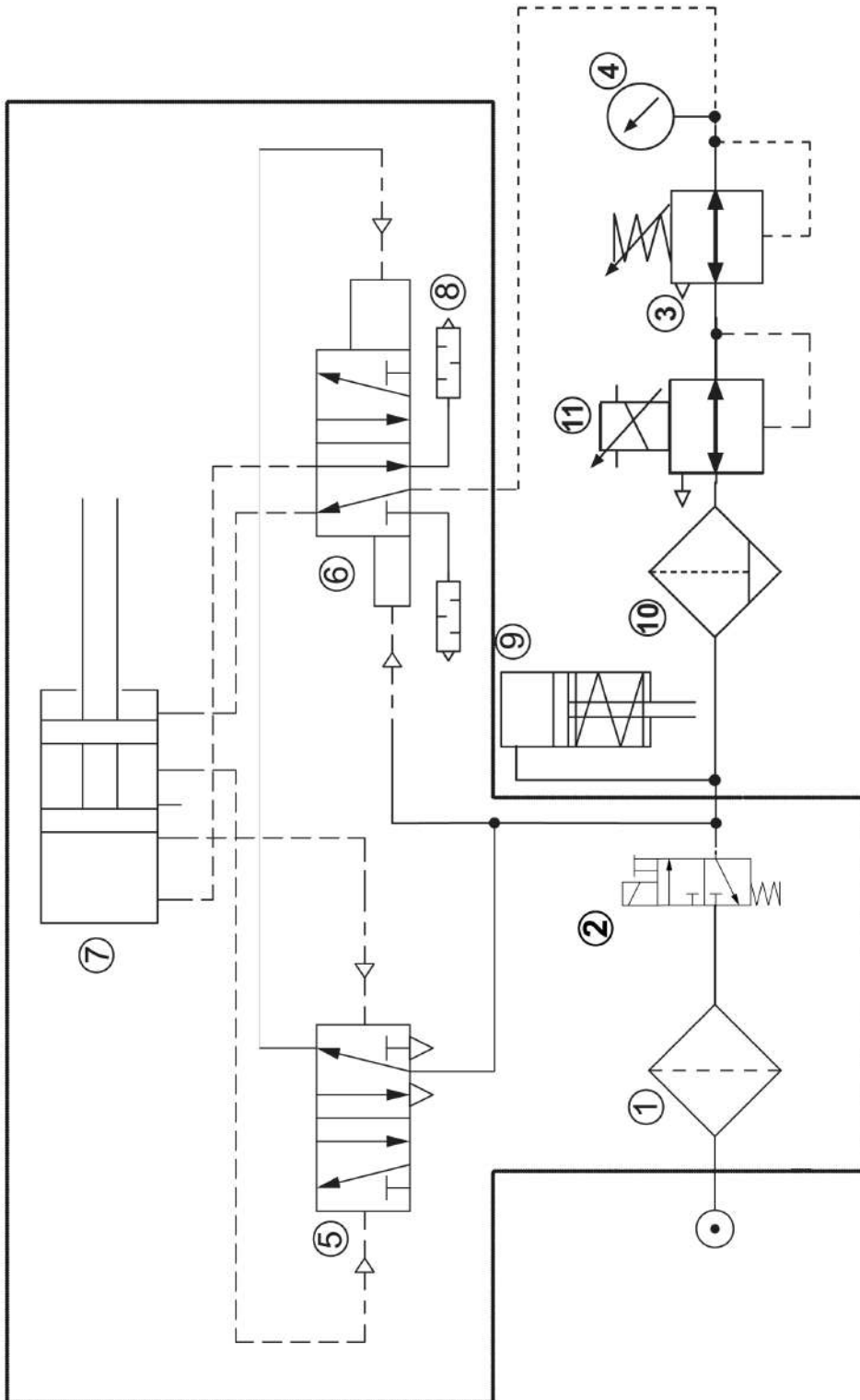

Electro-pneumatic connection with pressure regulator VP. 19 cm³/stroke PUMP

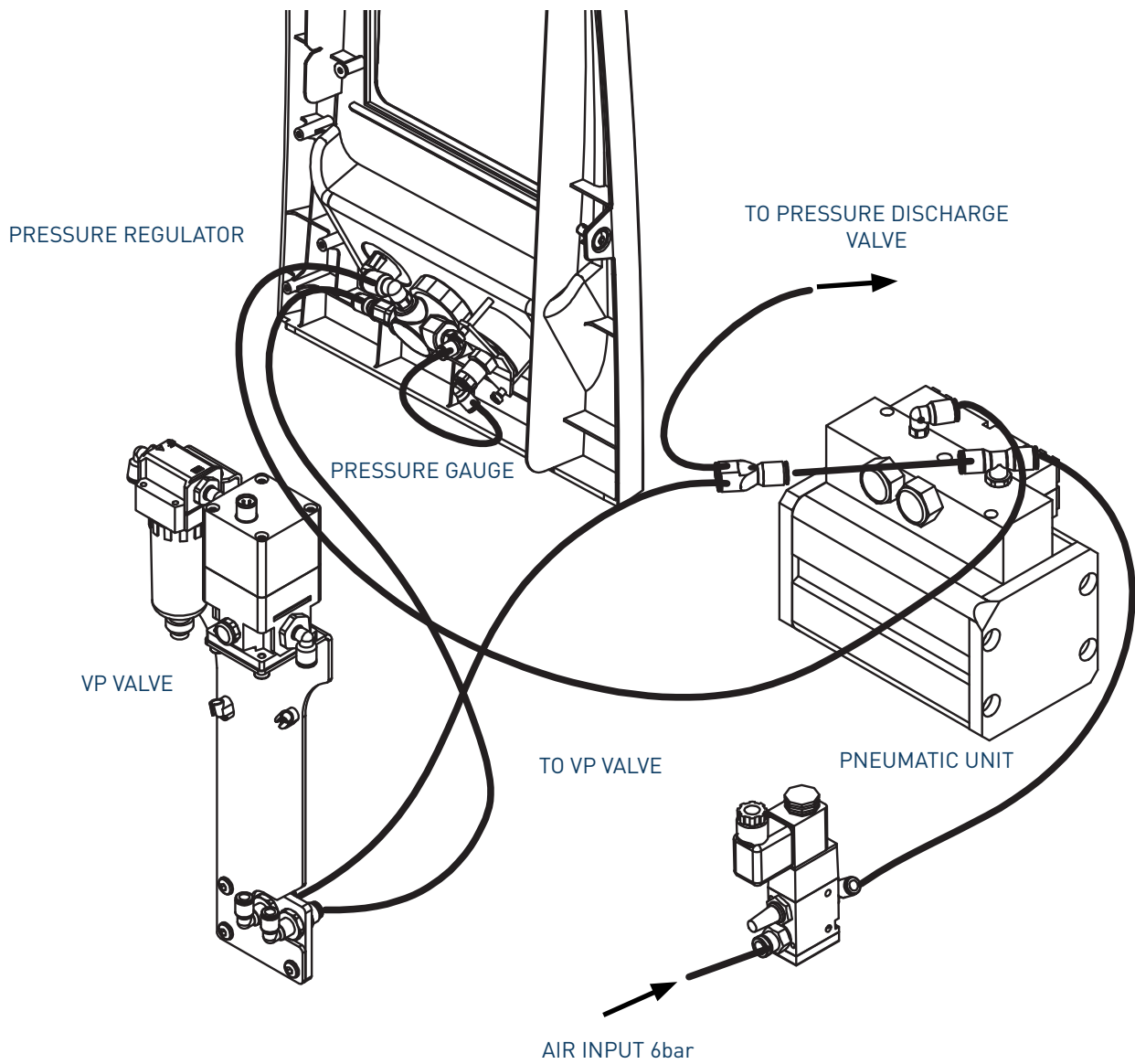

Electro-pneumatic diagram with pressure regulator VP.
19 cm³/stroke PUMP

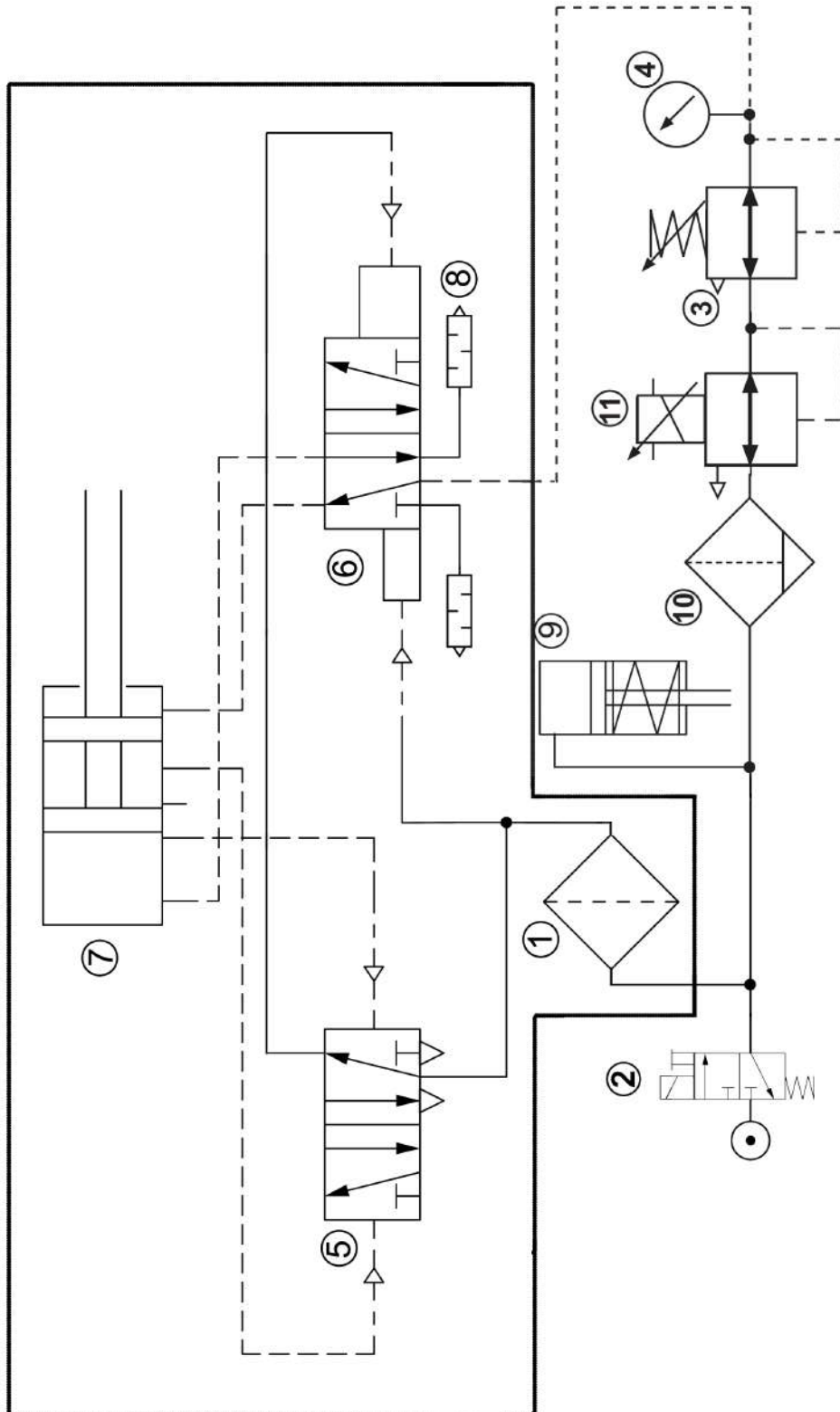

This page is intentionally left blank.

9. SPARE PARTS LIST

The list of the most common spare parts for MICRON+ series machines appears in this section, providing a quick and reliable guide to choosing them.

The spare parts are grouped together naturally, in the same way as they are located in the melters.

As a visual aid, drawings of the parts are included and are numbered to help identify them in the list. For further information about the content of the spare parts, click on the number of the spare part.

The lists provide the reference and name of the spare part, indicating, when necessary, whether the reference corresponds to the 5-, 10-, 20- or 35-litre model.



This page is intentionally left blank.

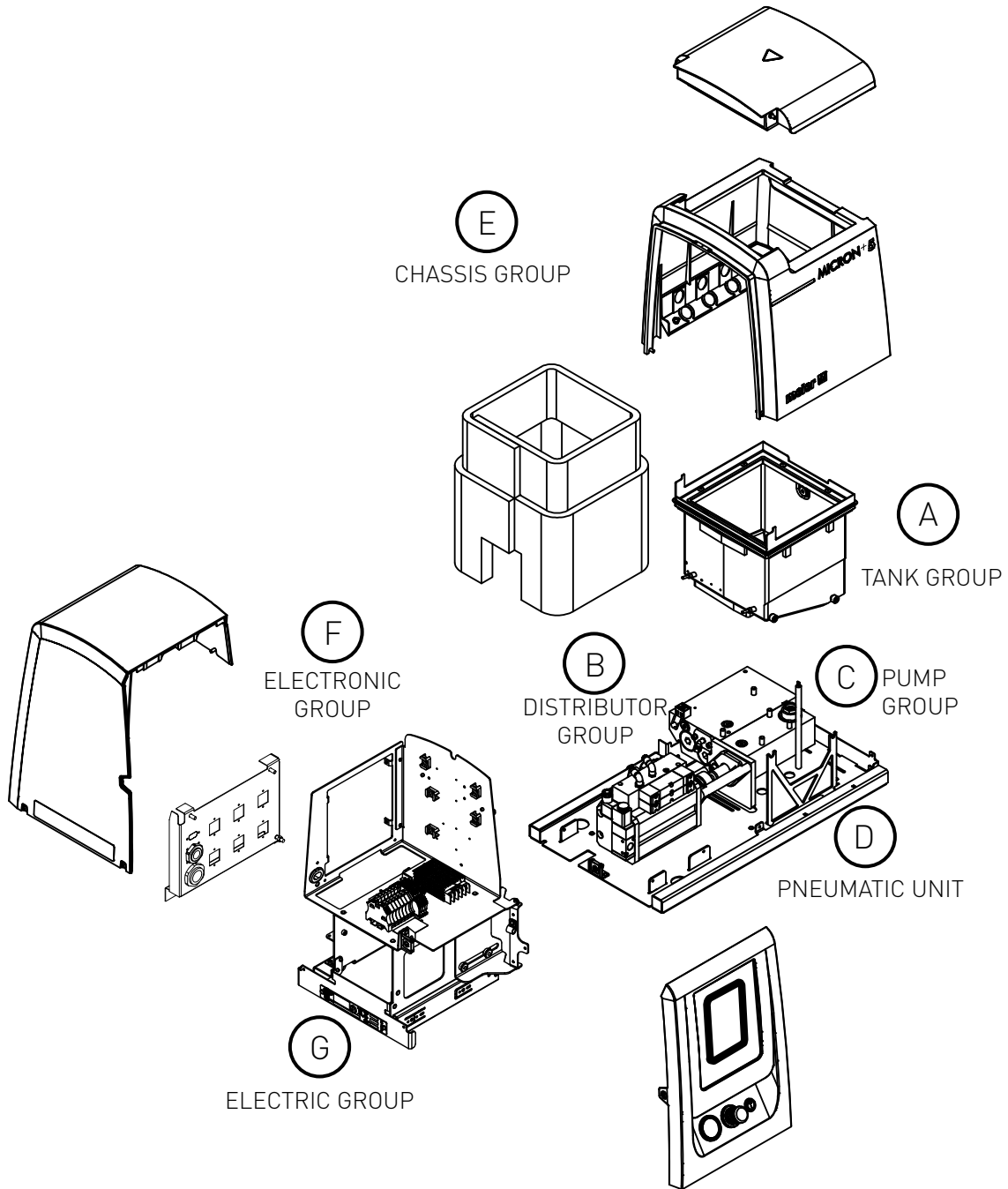

H, I, J - Spare parts for automatic feeder

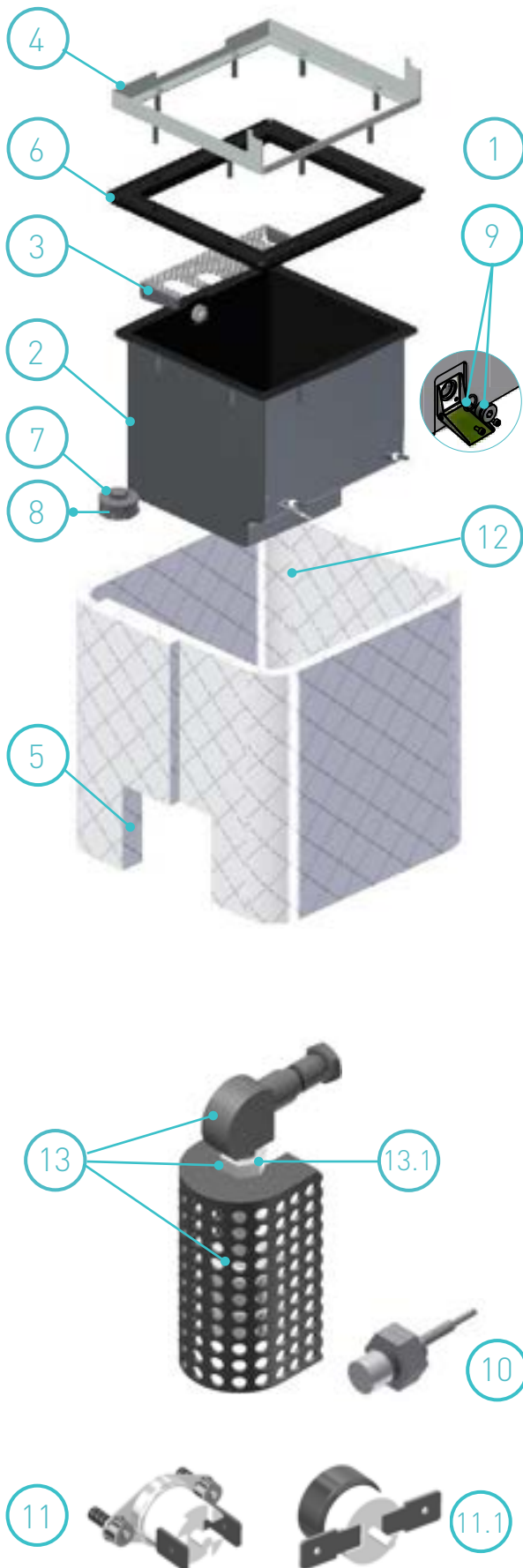

A. TANK ASSEMBLY

N°	Ref.	Description
1	150113470	Complete tank assembly micron 5 230V
1	150113480	Complete tank assembly micron 10 230V
1	150113490	Complete tank assembly micron 20 230V
1	150114890	Complete tank assembly micron 35 230V
2	150113500	PTFE coated tank micron 5 230V
2	150113510	PTFE coated tank micron 10 230V
2	150113520	PTFE coated tank micron 20 230V
2	150114900	PTFE coated tank micron 35 230V
3	150113370	Tank grid micron 5-10L
3	150114880	Tank grid micron 20L
3	150028830	Tank grid micron 35L
4	150113380	Inlet tank micron 5
4	150113390	Inlet tank micron 10
4	150113400	Inlet tank micron 20
4	150121360	Inlet tank micron 35
5	150113410	Tank insulation mantle micron 5
5	150113420	Tank insulation mantle micron 10
5	150113430	Tank insulation mantle micron 20
5	150114920	Tank insulation mantle micron 35
6	150113440	Insulation mantle inlet tank micron 5
6	150113450	Insulation mantle inlet tank micron 10
6	150113460	Insulation mantle inlet tank micron 20
6	150121370	Insulation mantle inlet tank micron 35
7	10100070	Flat tank filter
7	10100085	Flat tank filter, extra-thick
8	10100071	Tank flat filter mesh
8	10100086	Flat tank filter screen, extra-thick
9	150113270	Drain plug with o-ring
10	150110140	Capacitive sensor (*)
11	150114500	Safety thermostat, up to 200°C
11.1	150114510	Safety thermostat, up to 230°C (*)
12	150130370	Sensor Pt100
12	150130360	Sensor Ni120
12	150123150	Sensor NTC-R
13	150122430	Level detector assembly micron (*)
13.1	150123620	Low level detector (*)

(*) optional

B. DISTRIBUTOR UNIT

N°	Ref.	Description
1	150026350	Heating element 300 W
2	10120032	Tank-distributor seating o-ring
3	150121390	Distributor filter assembly
3.1	150121380	Filter head with purger
3.2	150029250	Filter mesh 50
3.3	150029260	O-ring 23 x 3
3.4	150026340	O-ring 7 x 1.5
3.5	150121350	O-rings filter assembly kit
3.6	150026330	Complete purger
4	150021820	Compensation valve assembly
4.1	150021830	Compensation valve piston/plunger assembly
4.2	10100096	Compensation valve spring
4.3	R0009267	Compensation valve shaft bushing
5	150022110	Compensation valve plug with O-ring
6	150024750	Depressurisation valve assembly
6.1	150024760	Pressure discharge valve o-rings. Seal Ø5
6.1	150131300	Pressure discharge valve o-rings. Seal Ø9,05
7	10100082	Pump plug with o-ring
7.1	10100083	Pump o-ring
8	150130370	Sensor Pt100
8	150130360	Sensor Ni120
8	150123150	Sensor NTC-R
9	150114940	Distributor- pump union micron 35
10	10030007	Current connection strip

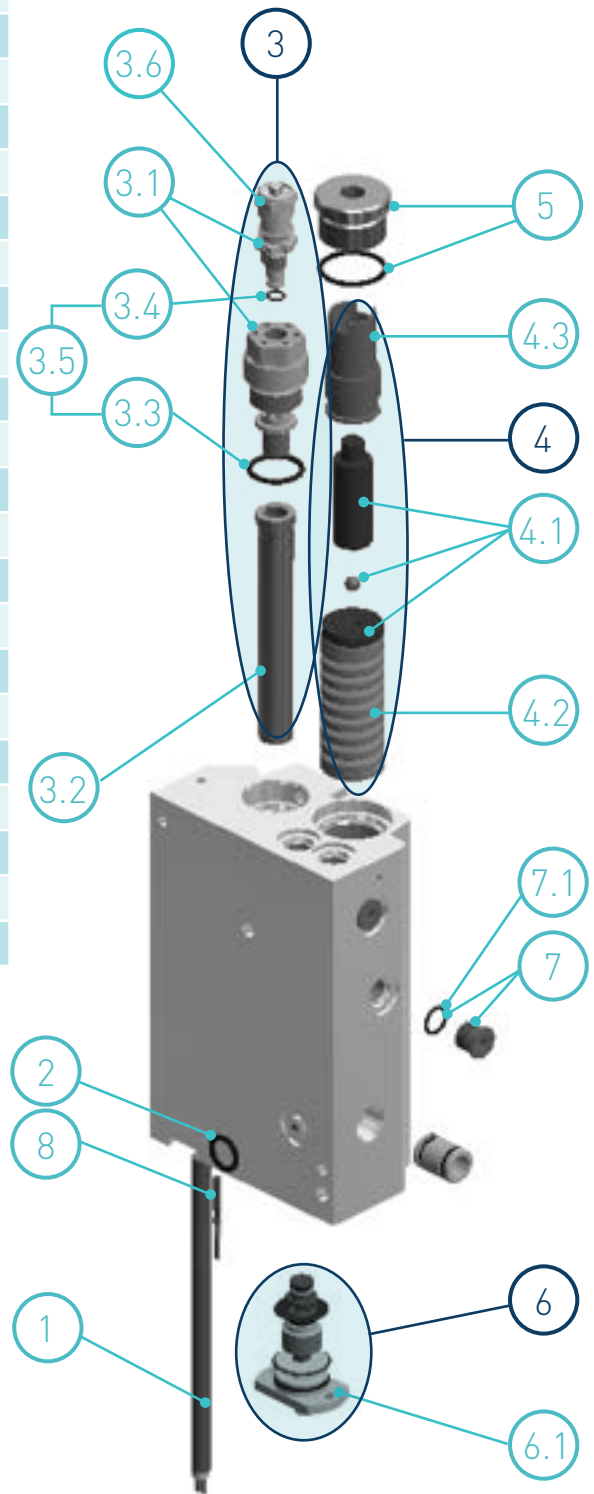
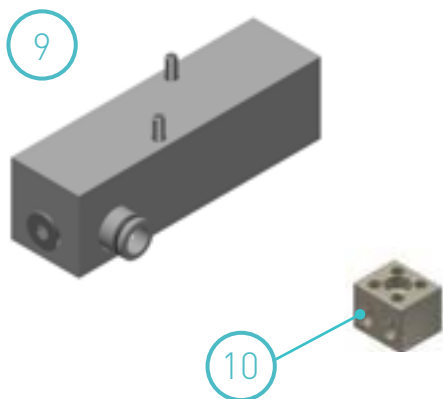

C. PUMP ASSEMBLY

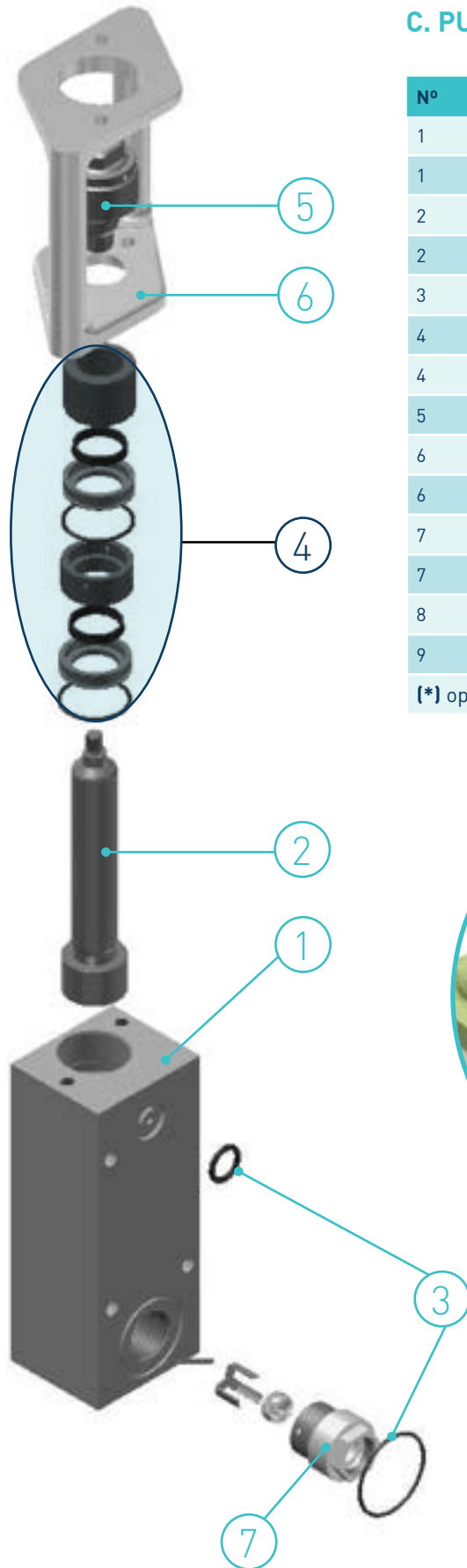

N°	Ref.	Description
1	150113550	7cc pump body with braces and fittings
1	150113560	19cc pump body with braces and fittings
2	10100011	Pump shaft 7cc
2	150023080	Pump shaft 19cc
3	150113570	Tank-pump-distributor seating O-ring kit
4	150113530	7cc pump guide bushing kit
4	150113540	19cc pump guide bushing kit
5	150020590	Short ball and socket joint for pump shaft activator
6	150113580	Pump holding support 7cc
6	150113590	Pump holding support 19cc
7	150024970	Inlet valve fitting micron pump 7cc
7	150024980	Inlet valve fitting micron pump 19cc
8	150127550	Cylinder magnetic LED sensor (*)
9	150127560	Magnetic flow sensor ring (*)

(*) optional

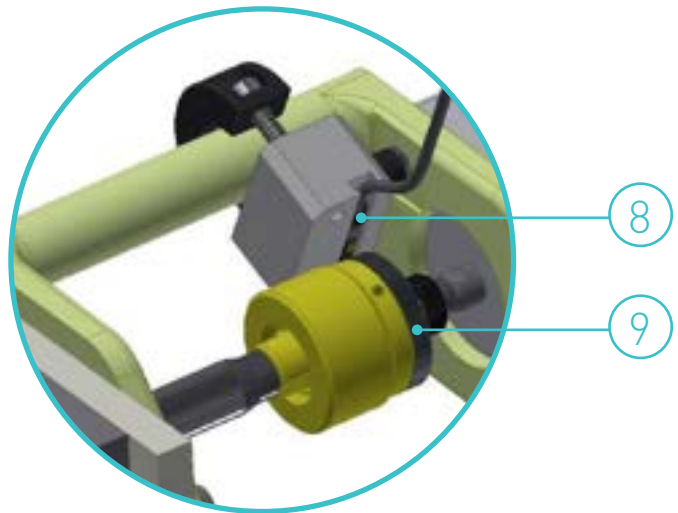

D. PNEUMATIC UNIT ASSEMBLY 7cc

N°	Ref.	Description
1	150123120	Pneumatic unit assembly with filter 7cc 24VDC
2	150113650	1/4' flat silencer
3	150114480	Pressure gauge
4	10110031	Pressure regulator
5	150113690	Connector kit for 7cc pump unit without VP
6	150020490	Differential valve with o-ring
7	150020500	Control valve with o-ring
8	150123650	Inlet solenoid valve (24V DC)
9	150060130	Solenoid valve connector
10	150020580	O-ring kit of pneumatic cylinder 7cc

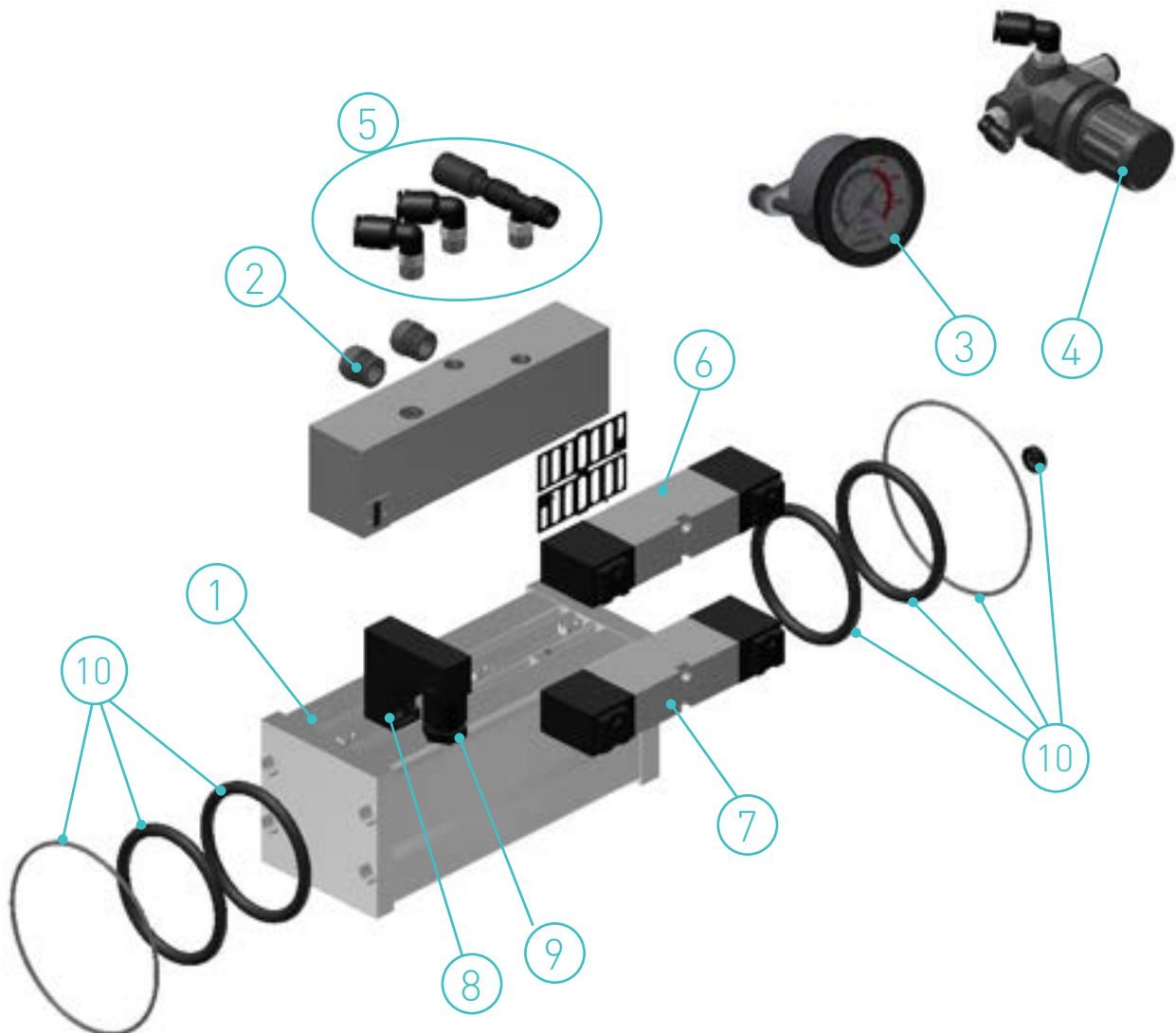

D. PNEUMATIC UNIT ASSEMBLY 19cc

N°	Ref.	Description
1	150113620	Pneumatic unit assembly 19cc with filter
2	150114480	Pressure gauge
3	10110031	Pressure regulator
4	150113850	Connector kit for 19cc pump unit without VP
5	150123660	Solenoid coil 19cc (24V)
6	150060040	Solenoid valve connector DIN 43650B
7	150123670	Intake solenoid valve (24V)
8	150020490	Differential valve with o-ring
9	150020500	Control valve with o-ring
10	150023330	Exhaust silencer
11	150023300	O-ring kit of pneumatic cylinder 19cc

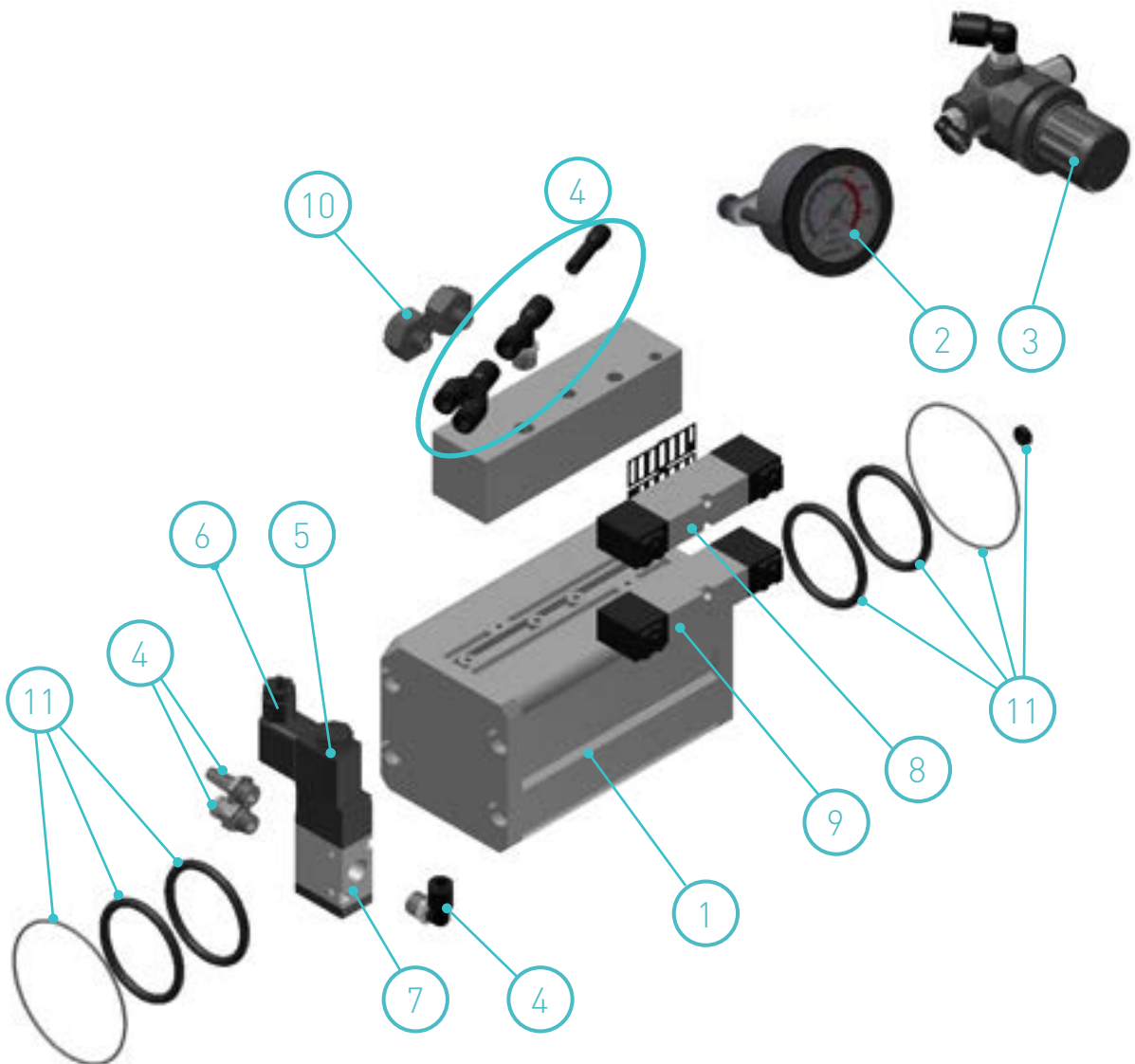

E. CHASSIS ASSEMBLY

N°	Ref.	Description
1	150130380	Micron electrical cabinet door casing Micron+
2	150130390	Electrical cabinet casing assembly without warning light
2	150130400	Electrical cabinet casing assembly with warning light
3	150122930	Micron+ 5 tank housing assembly
3	150122940	Micron+ 10 tank housing assembly
3	150122950	Micron+ 20 tank housing assembly
3	150122960	Micron+ 35 tank housing assembly
4	150130410	Micron+ 5 tank cover assembly
4	150130420	Micron+ 10 tank cover assembly
4	150130430	Micron+ 20 tank cover assembly
4	150130440	Micron+ 35 tank cover assembly



F. ELECTRONIC ASSEMBLY

Nº	Ref.	Denominación
1	150122970	HMI micron+ control board
2	150122980	Temperature control board 2 outputs
2	150122990	Temperature control board 6 outputs
3	150114760	Capacitive sensor and amplifier kit (*)
4	R0001938	Solid state relay 40A
5	150125580	Micron + wifi communication antenna card kit (*)
6	150126180	Fuse 10A 5x20 electrical outputs
6	150126170	Fuse 10A 6,3x32 distributor
6	150126160	Fuse 16A 6,3x32 tank
7	150127540	I/O flowmeter micron+ control board (*)
8	150130520	Power supply 24V 2,2A
8	150030620	Power supply 24V 4,5A

(*) optional

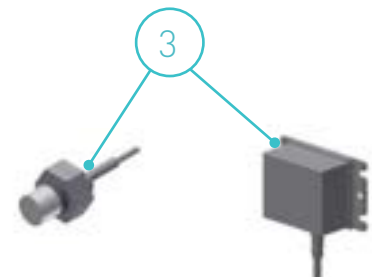
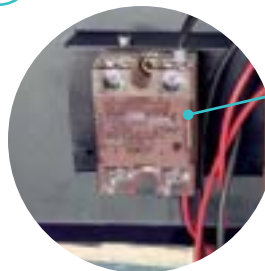
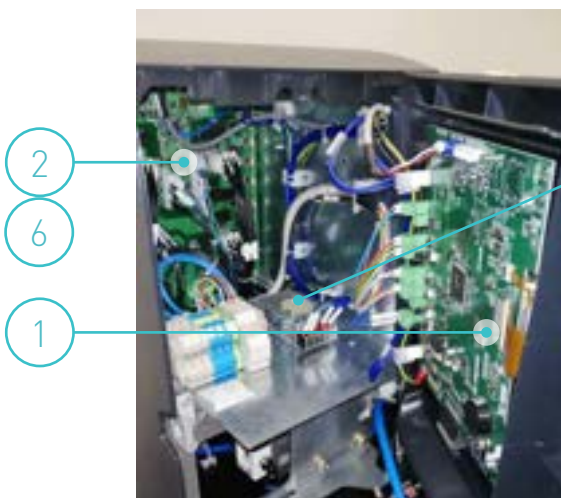
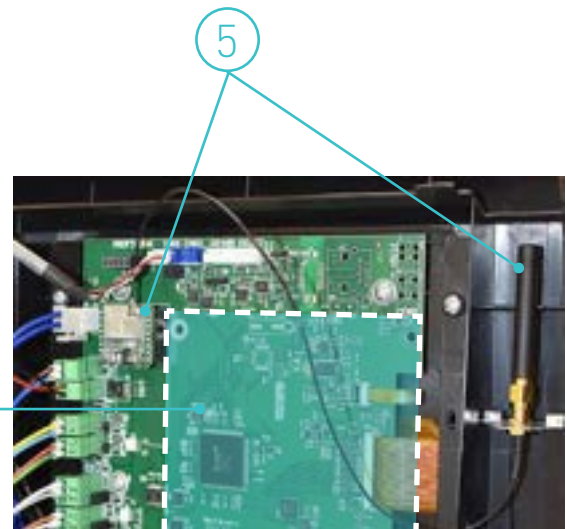

G. ELECTRIC ASSEMBLY

N°	Ref.	Description
1	16010003	Female connector 8 pin PT-100 (base housing)
2	150020720	Female connector 12 pin Ni-120 (base housing)
3	150130450	Female connector 8 pin NTC (base housing)
4	150123000	Cable gland Pg 21 black
5	150119190	Cable gland Pg16 black
6	150114470	Main switch

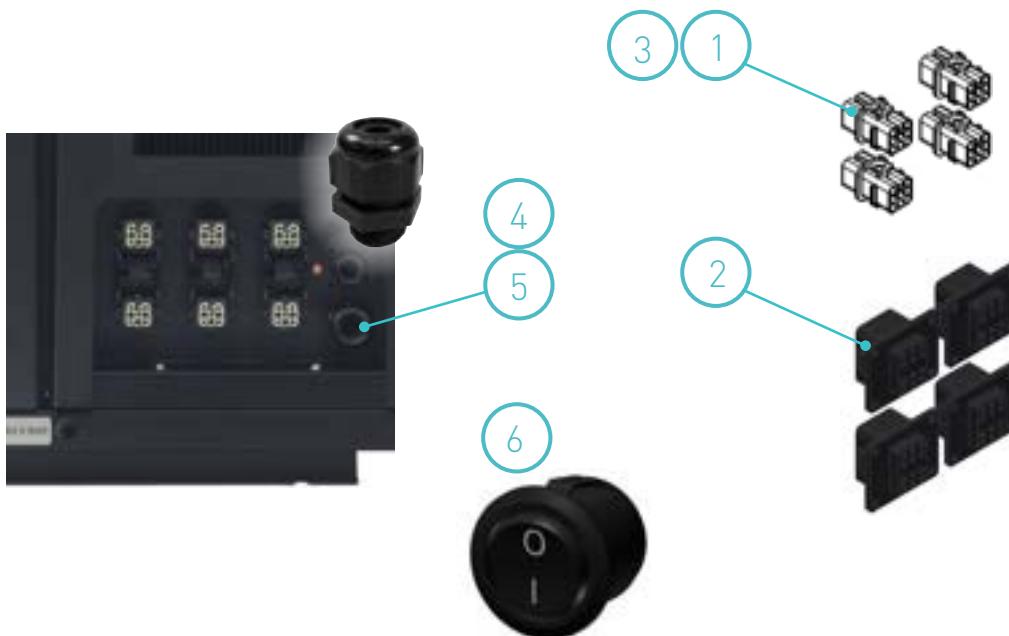

H. AUTOMATIC FEEDER. FILTER- SENSOR ASSEMBLY

N°	Ref.	Description
1	150025800	Capacitive level sensor (amplifier and probe)
2	150025770	Grid filter 20 mesh
3	150025870	Capacitive level sensor o-rings



I. AUTOMATIC FEEDER. SUCTION TUBE

N°	Ref.	Description
1	150025650	Fitting Y Ø10 quick plug
2	150025660	Hose vacuum feeder Ø30 (meter)
3	150025670	Metal suction tube
4	150025680	Venturi suction tube
5	150025690	Support for suction tube
6	150025700	Fitting 90° 3/8 Ø10 quick plug
7	150025710	Pneumatic vibrator vacuum feeder
8	21300000	Silencer
9	150110180	Straight fitting 1/8 Ø4 quick plug
10	150025740	Reduction Ø10-Ø4 quick plug
	150025810	Complete suction tube vacuum feeder

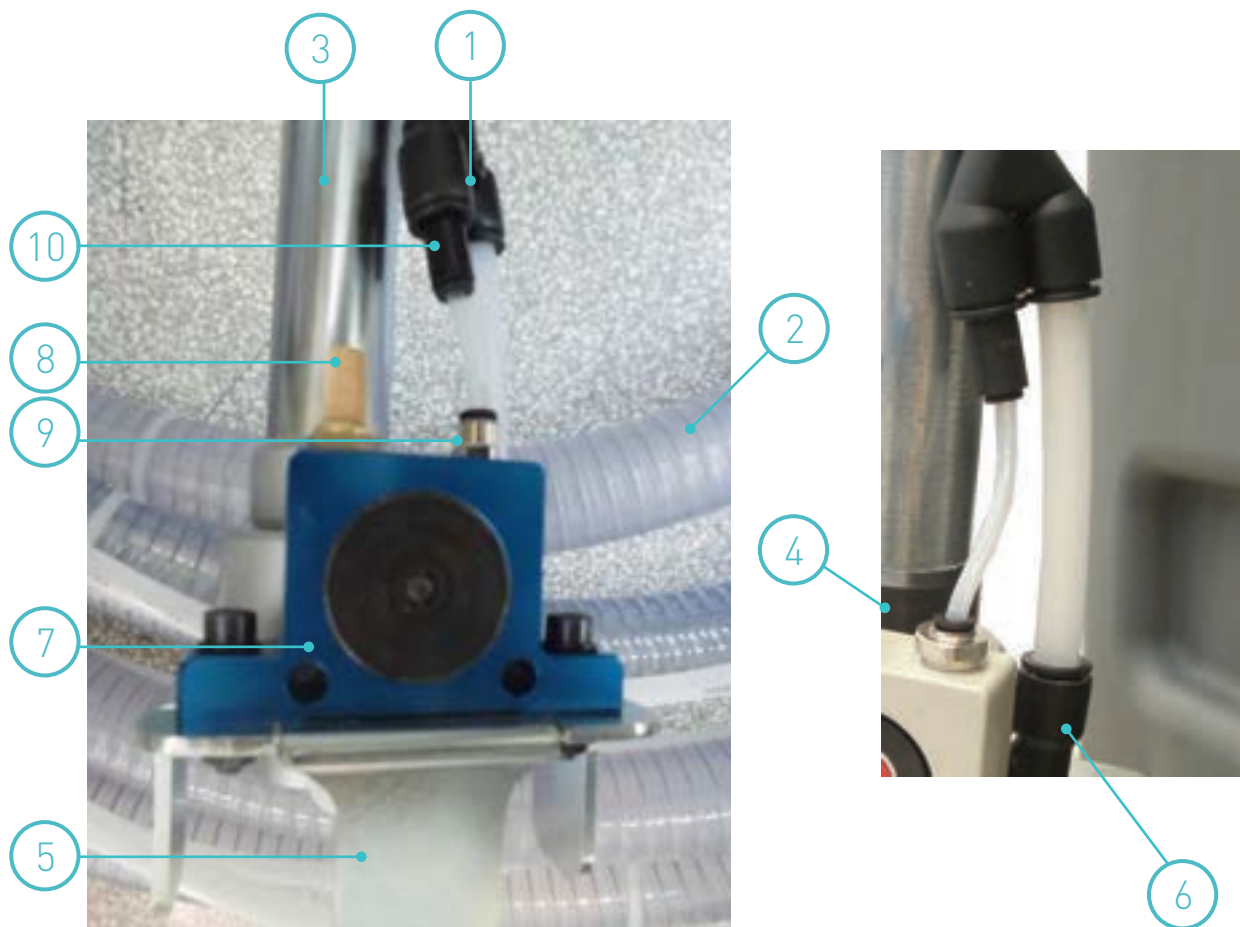

J. AUTOMATIC FEEDER. VALVE ASSEMBLY

Nº	Ref.	Denominación
1	150025750	Fitting 90° 1/4 Ø10
2	150060080	Coil for solenoid valve 24 VDC (10W)
3	150060050	Solenoid valve connector
4	150060070	Complete solenoid valve 2/2 24VDC 5W
5	150025790	Fitting 90° 3/8 Ø10 quick plug

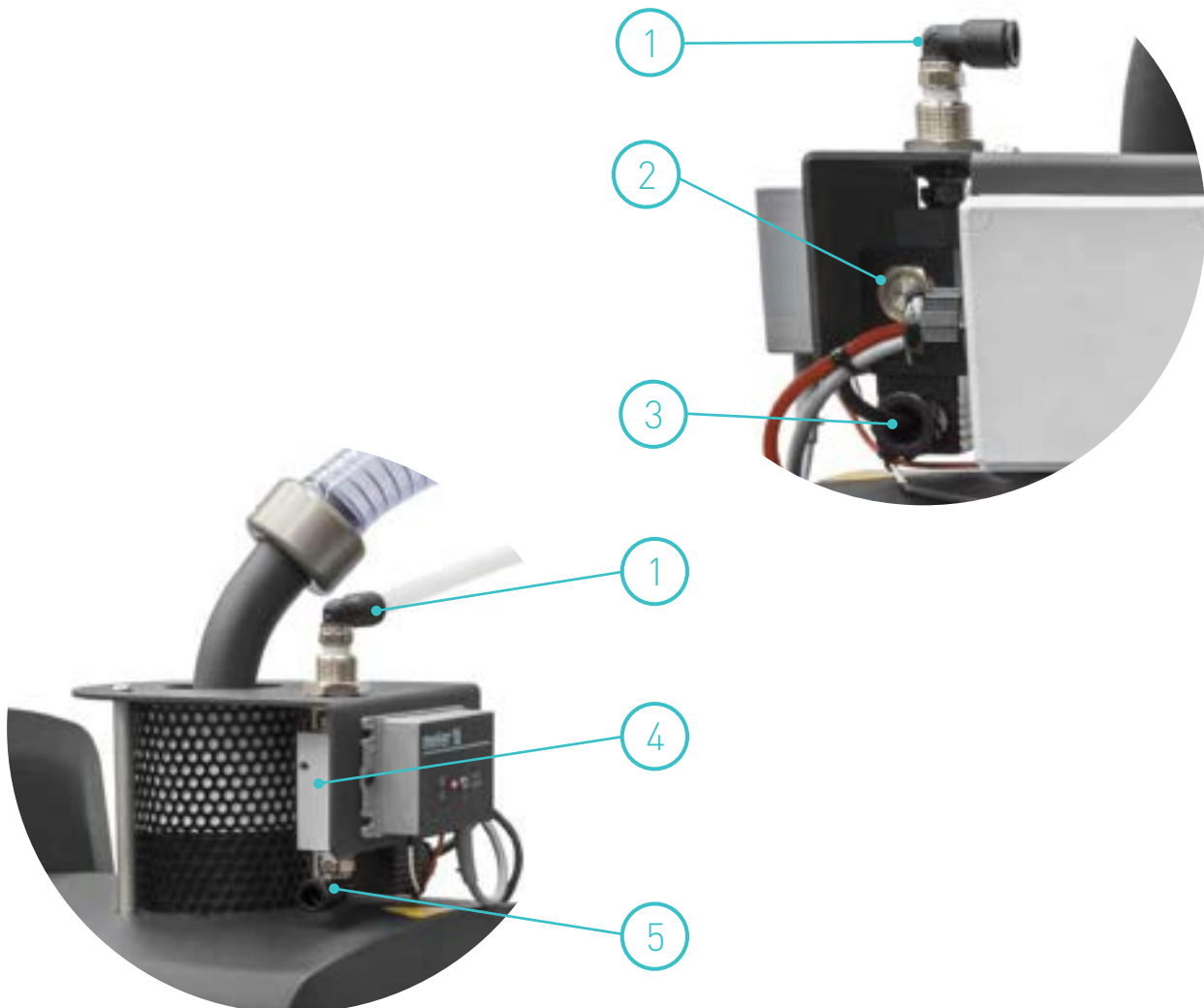

EC DECLARATION OF CONFORMITY

Original Declaration

The manufacturer,

Focke Meler Gluing Solutions, S.A.

Pol. Arazuri-Orkoien, c/B, nº3 A
E-31170 Arazuri - Navarra - Spain

— Focke Group —

declaring that the machinery, Type:

Model:

Serial Number:

fulfils all the relevant provisions of the Directive 2006/42/EC on machinery,

and the object of the declaration described above is in conformity with the relevant Union harmonisation legislation:

- Directiva 2014/30/EU on the harmonisation of the laws of the Member States relating to electromagnetic compatibility .
- Directiva 2011/65/EU and its amendments on the restriction of the use of certain hazardous substances in electrical and electronic equipment.

In reference to the harmonised standards:

- EN ISO 12100:2010. Safety of machinery - General principles for design - Risk assessment and risk reduction.
- EN ISO 13732-1:2008. Ergonomics of the thermal environment - Methods for the assessment of human responses to contact with surfaces - Part 1: Hot surfaces.
- EN ISO 13849-1:2015. Safety of machinery - Safety-related parts of control systems - Part 1: General principles for design.
- EN ISO 14120:2015. Safety of machinery - Guards - General requirements for the design and construction of fixed and movable guards.
- EN 60204-1:2018. Safety of machinery - Electrical equipment of machines - Part 1: General requirements.
- EN 61000-6-2:2005, +/AC:2005. Electromagnetic compatibility (EMC) - Part 6-2: Generic standards - Immunity for industrial environments.
- EN 61000-6-4:2007, +/A1:2011. Electromagnetic compatibility (EMC) - Part 6-4: Generic standards - Emission standard for industrial environments.
- EN 50581:2012. Technical documentation for the assessment of electrical and electronic products with respect to the restriction of hazardous substances.

This declaration of conformity is issued under the sole responsibility of the manufacturer.

The person authorised to compile the technical file is the manufacturer established at the above address in this declaration.

Signed in Arazuri, to date:



Javier Aranguren
Managing Director

This page is intentionally left blank.

EC DECLARATION OF CONFORMITY

(Only for equipments with wifi system integrated)

Original Declaration

The manufacturer,

Focke Meler Gluing Solutions, S.A.

Pol. Arazuri-Orkoien, c/B, nº3 A
E-31170 Arazuri - Navarra - Spain

— Focke Group —

declaring that the machinery, Type:

Model:

Serial Number:

fulfils all the relevant provisions of the Directive 2006/42/EC on machinery,

and the object of the declaration described above is in conformity with the relevant Union harmonisation legislation:

- Directive 2014/30/EU on the harmonisation of the laws of the Member States relating to electromagnetic compatibility .
- Directive 2011/65/EU and its amendments on the restriction of the use of certain hazardous substances in electrical and electronic equipment.
- Directive 2014/53/EU on the harmonisation of the laws of the Member States relating to the making available on the market of radio equipment.

In reference to the harmonised standards:

- EN ISO 12100:2010. Safety of machinery - General principles for design - Risk assessment and risk reduction.
- EN ISO 13732-1:2008. Ergonomics of the thermal environment - Methods for the assessment of human responses to contact with surfaces - Part 1: Hot surfaces.
- EN ISO 13849-1:2015. Safety of machinery - Safety-related parts of control systems - Part 1: General principles for design.
- EN ISO 14120:2015. Safety of machinery - Guards - General requirements for the design and construction of fixed and movable guards.
- EN 60204-1:2018. Safety of machinery - Electrical equipment of machines - Part 1: General requirements.
- EN 61000-6-2:2005, +/AC:2005. Electromagnetic compatibility (EMC) - Part 6-2: Generic standards - Immunity for industrial environments.
- EN 61000-6-4:2007, +/A1:2011. Electromagnetic compatibility (EMC) - Part 6-4: Generic standards - Emission standard for industrial environments.
- EN 50581:2012. Technical documentation for the assessment of electrical and electronic products with respect to the restriction of hazardous substances.
- ETSI EN 300 328 V2.1.1 Wideband transmission systems; Data transmission equipment operating in the 2,4 GHz ISM band and using wide band modulation techniques; Harmonised Standard covering the essential requirements of article 3.2 of Directive 2014/53/EU.
- Draft ETSI EN 301 489-1 V2.2.0 ElectroMagnetic Compatibility (EMC) standard for radio equipment and services; Part 1: Common technical requirements; Harmonised Standard covering the essential requirements of article 3.1(b) of Directive 2014/53/EU and the essential requirements of article 6 of Directive 2014/30/EU.
- Draft ETSI EN 301 489-17 V3.2.0 ElectroMagnetic Compatibility (EMC) standard for radio equipment and services; Part 17: Specific conditions for Broadband Data Transmission Systems; Harmonised Standard covering the essential requirements of article 3.1(b) of Directive 2014/53/EU.

This declaration of conformity is issued under the sole responsibility of the manufacturer.

The person authorised to compile the technical file is the manufacturer established at the above address in this declation.

Signed in Arazuri, to date:

v1221



Javier Aranguren
Managing Director

For more information speak with your Focke Meler representative:



Focke Meler Gluing Solutions, S.A.
Pol. Arazuri-Orkoién, c/B, nº3 A
E-31170 Arazuri - Navarra - Spain
Phone: +34 948 351 110
info@meler.eu - www.meler.eu

Focke Group